



NTSC U/C

PlayStation™

# PANZER GENERAL™



KIDS TO ADULTS



SLUS-00132  
082141



A MINDSCAPE® COMPANY

**WARNING: READ BEFORE USING YOUR PLAYSTATION GAME CONSOLE.**

A very small percentage of individuals may experience epileptic seizures when exposed to certain light patterns or flashing lights. Exposure to certain patterns or backgrounds on a television screen or while playing video games, including games played on the PlayStation game console, may induce an epileptic seizure in these individuals. Certain conditions may induce previously undetected epileptic symptoms even in persons who have no history of prior seizures or epilepsy. If you, or anyone in your family, has an epileptic condition, consult your physician prior to playing. If you experience any of the following symptoms while playing a video game – dizziness, altered vision, eye or muscle twitches, loss of awareness, disorientation, any involuntary movement, or convulsions – IMMEDIATELY discontinue use and consult your physician before resuming play.

**WARNING TO OWNERS OF PROJECTION TELEVISIONS:**

Still pictures or images may cause permanent picture-tube damage or mark the phosphor of the CRT, avoid repeated or extended use of video games on large-screen projection televisions. Refer to your projection TV instruction manual for more details.

**HANDLING YOUR PLAYSTATION DISC:**

- This compact disc is intended for use only with the PlayStation game console.
- Do not bend it, crush it or submerge it in liquids
- Do not leave it in direct sunlight or near a radiator or other source of heat.
- Be sure to take an occasional rest break during extended play.
- Keep this compact disc clean. Always hold the disc by the edges and keep it in its protective case when not in use. Clean the disc with a lint-free, soft, dry cloth, wiping in straight lines from center to outer edge. Never use solvents or abrasive cleaners.

## TABLE OF CONTENTS

GETTING STARTED .....	1
<i>What Comes with This Game</i> .....	1
<i>Game Controls</i> .....	1
<i>Choosing a Controller Configuration Set</i> .....	2
<i>Saving or Restarting the Game</i> .....	2
TUTORIAL/QUICK START .....	3
<i>Setting Preferences</i> .....	3
<i>Game Turns</i> .....	5
<i>Battle Plan</i> .....	6
<i>Tactics Checklist</i> .....	17
STARTING A NEW GAME .....	18
<i>Start Game Menu</i> .....	18
<i>Starting A Campaign Game</i> .....	18
<i>Loading a Saved Game</i> .....	18
<i>Information</i> .....	18
MENUS .....	19
<i>Main Menu</i> .....	19
<i>Options Menu</i> .....	21
<i>Unit Menu</i> .....	23
GAME PLAY .....	29
<i>The Tactical Map</i> .....	29
<i>Beginning and Ending a Battle</i> .....	29
UNIT CLASS DESCRIPTIONS .....	38
<i>Ground Classes</i> .....	38
<i>Air Classes</i> .....	42
<i>Sea Classes</i> .....	43

This product has been rated by the Entertainment Software Rating Board. For information about the ESRB rating, or to comment about the appropriateness of the rating, please contact the ESRB at 1-800-771-3772.

# PlayStation Game Console Setup and Game Startup Information

## CONSOLE

### Top View

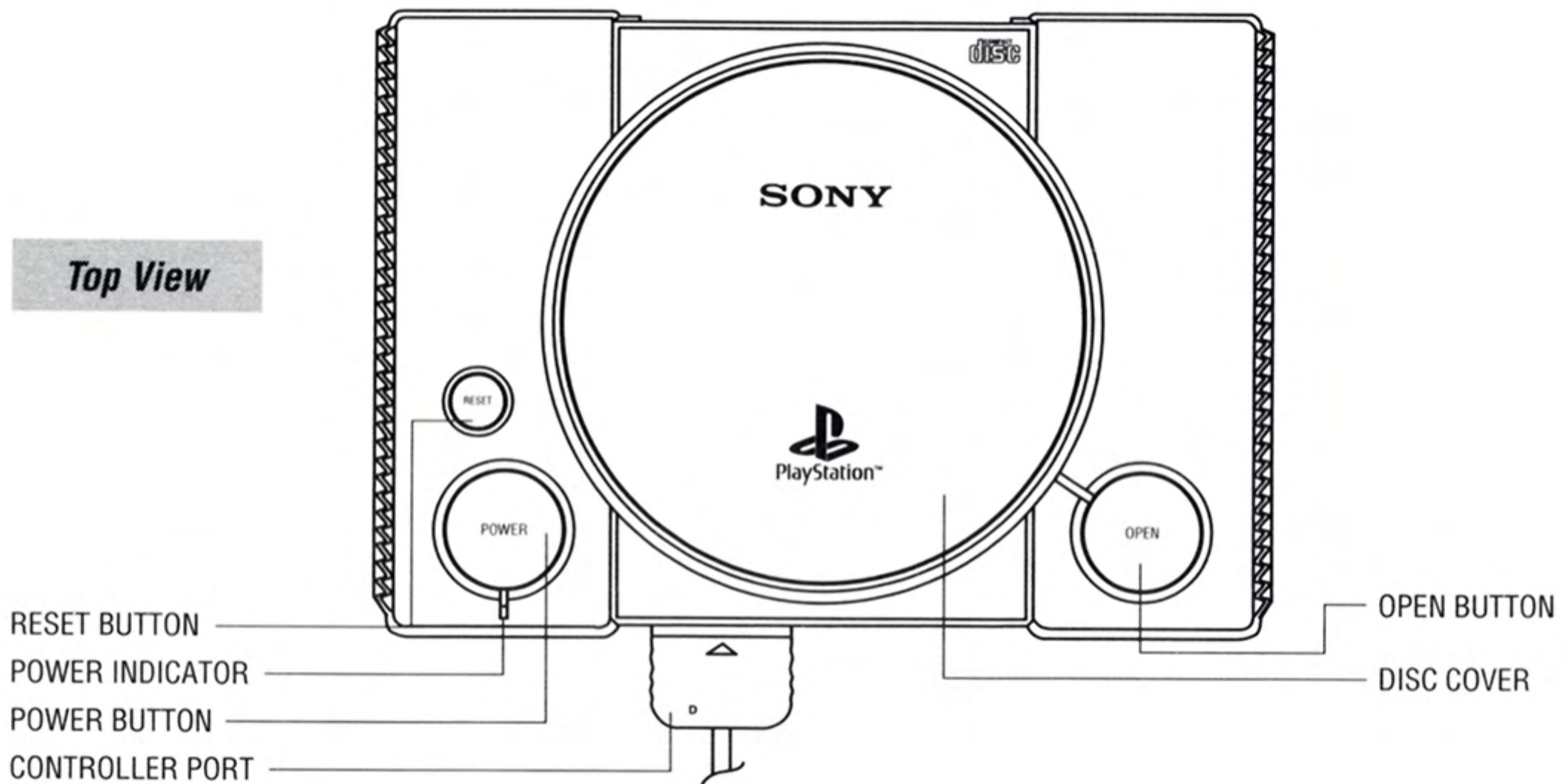

### Front View

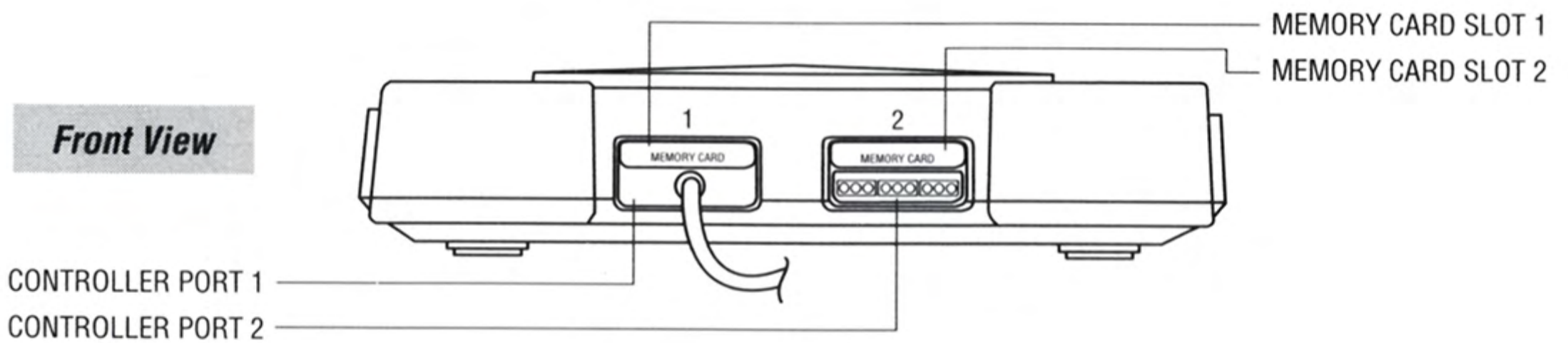

Set up your PlayStation game console according to the instructions in its Instruction Manual. Make sure the power is off before inserting or removing a compact disc. Insert the PANZER GENERAL disc and close the CD door. Insert game controllers and turn on the PlayStation. Follow on-screen instructions to start a game.

# Controller

## CONTROLLER

### Front View

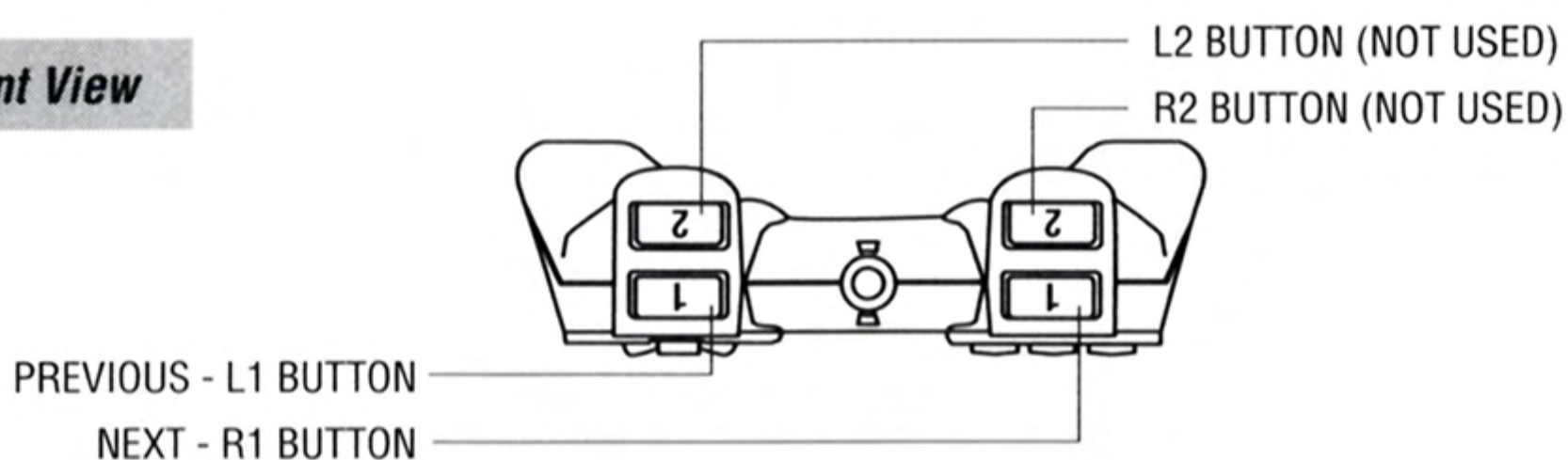

### Top View

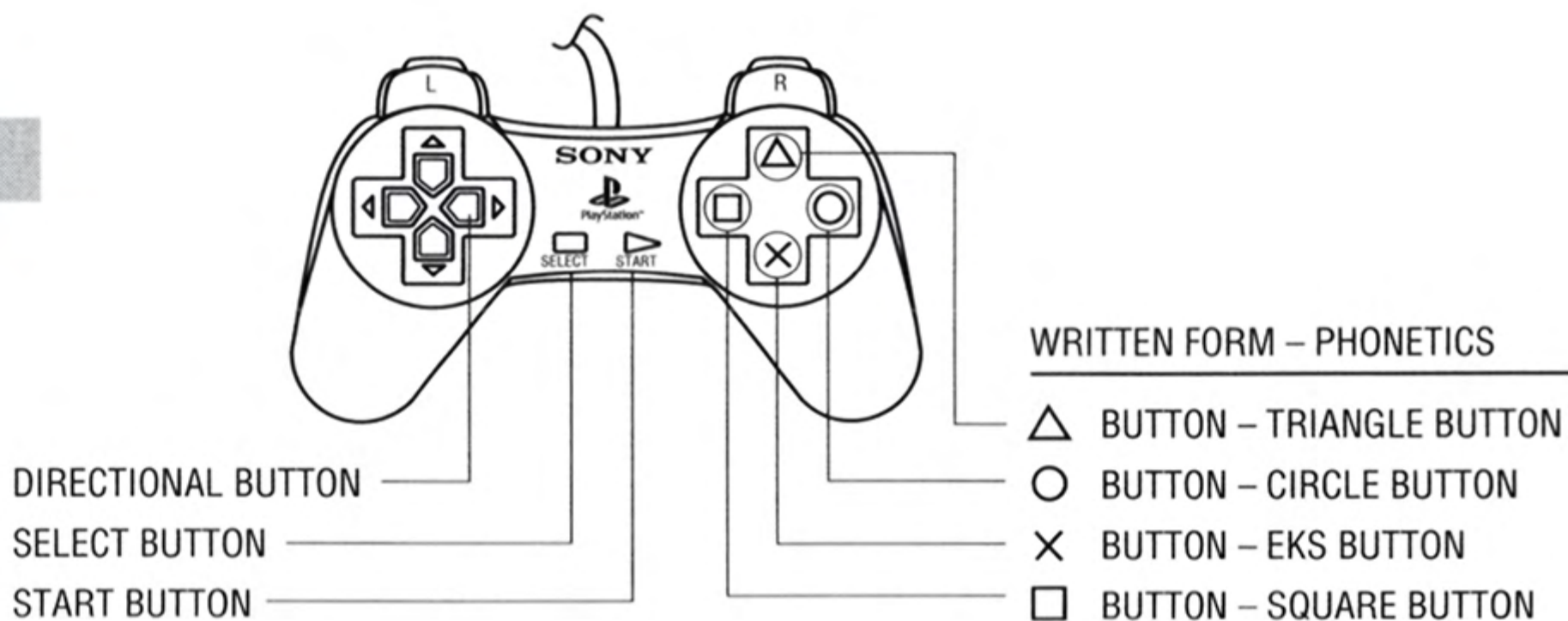

## GETTING STARTED

If you want to get a quick start, refer to the “Tutorial/Quick Start” section of the manual which begins on page 3. It provides a step-by-step battle plan to familiarize you with the menus and aspects of a PANZER GENERAL scenario, and should help you win the first battle of the 1939 Blitzkrieg. If, however, you prefer to familiarize yourself with the game as a whole, turn to the “Menus” and “Game Play” sections on pages 19, and 29, respectively.

### What Comes with This Game

Your game box should contain this rule book and a CD-ROM. The rule book explains how to play and contains important information on menus, scenarios, unit classes, and equipment.

### Game Controls

This manual uses the word “button” to refer to two different things. One reference is to the Next, Previous,  $\times$ ,  $\circ$ ,  $\square$ , and  $\triangle$  buttons on the game controller. The Next button is the top-right button on the front of the controller and the Previous button is the top-left button on the front of the controller. See the “PlayStation™ Controller” diagram in the front of this manual for more information.

- ◆ The  $\times$  button controls units. Use the  $\times$  button to move, shoot, and inspect your own and any enemy units that are visible.
- ◆ The  $\circ$  button takes you from the Tactical Map to menus where you can set preferences, issue commands, and is also used to accept choices and return to the game.
- ◆ The  $\square$  button exits all menus without accepting any selections. On the Tactical Map, pressing the  $\square$  button also releases the currently active unit. When used by itself, the  $\square$  button returns to play from any menu.
- ◆ Holding down the  $\triangle$  button while pressing the Previous button zooms in; the  $\triangle$  button and Next buttons zoom out. Pressing a directional button while holding down the  $\triangle$  button shifts the Strategic map that direction to enable you to view larger strategic maps.

Buttons also refer to the rectangular icons found on menus which control many of the game’s preferences. They are operated by using the directional buttons to highlight them and pressing the  $\times$  button. This is referred to in the rest of this manual as “pressing” that button.

## Choosing a Controller Configuration Set

Pressing the select button on the controller, while at the Start Game Menu, presents the Button Options Menu. There are four ways the X, O, □, and △ buttons may be con-



figured. Pressing the button next to each Option button displays the control set changes on the right side of the window. This manual is written based on using the default configuration set, which is also Option 1.

**Note:** Regardless of what Option set is visible on the menu, the configuration only changes after the OKAY button is pressed and a game is started. Pressing the OKAY button returns to the Start Game Menu. Pressing the Exit button returns to the Start Game Menu without changing the configuration. Configuration option 1 will remain in effect until a game is started.

## Saving or Restarting the Game

 The CD icon on the Options Menu is called the Load/Save/Quit button and is used for loading or saving games. **Note:** Only PlayStation systems equipped with memory cards will be able to save games. Pressing the Save button presents the Save Menu. There are four save positions, and the game will be saved using the name of the current scenario and the turn number. Once you have selected a save position,



press the X button. Pressing the □ button returns to the Options Menu without saving.

Holding down the Select button, and then pressing and holding down the Start button for two seconds abandons the game in progress and returns to the beginning of the game. Using these buttons in the opposite order,

that is, pressing and holding down the Start button and then the Select button has the same effect, but prompts for confirmation that the game should be continued or abandoned.

## TUTORIAL/QUICK START



This tutorial provides step-by-step suggestions to familiarize you quickly and easily with the basic menus, options, and units in the first PANZER GENERAL battle scenario of the 1939 Blitzkrieg.

From the Start Game Menu, your choices are: Scenario, Campaign, Load or Information. Use the directional buttons to

highlight the Scenario button, and press the  $\times$  button to activate it.

### Setting Preferences

The Set Scenario and Set Control menus appear when you press the Scenario button. The Set Control menu has a human control and a computer control button for each side. The Set Scenario menu has buttons for changing the difficulty level, the scenario, Start to start playing, and Exit or  $\square$  to quit without making any changes.

The difficulty level starts out on the EASY setting. Pressing the button next to this setting opens the Set Difficulty and Settings menus. The Set Difficulty menu can be set to EASY, MEDIUM, HARD, or CUSTOM. The CUSTOM setting gives you the chance to adjust the computer's "Artificial Intelligence" (AI) by choosing how much experience and prestige the computer is given during play.



Later, if you play games between two human players or set the game up to play itself, a two panel screen appears where you can adjust prestige and experience for both sides.



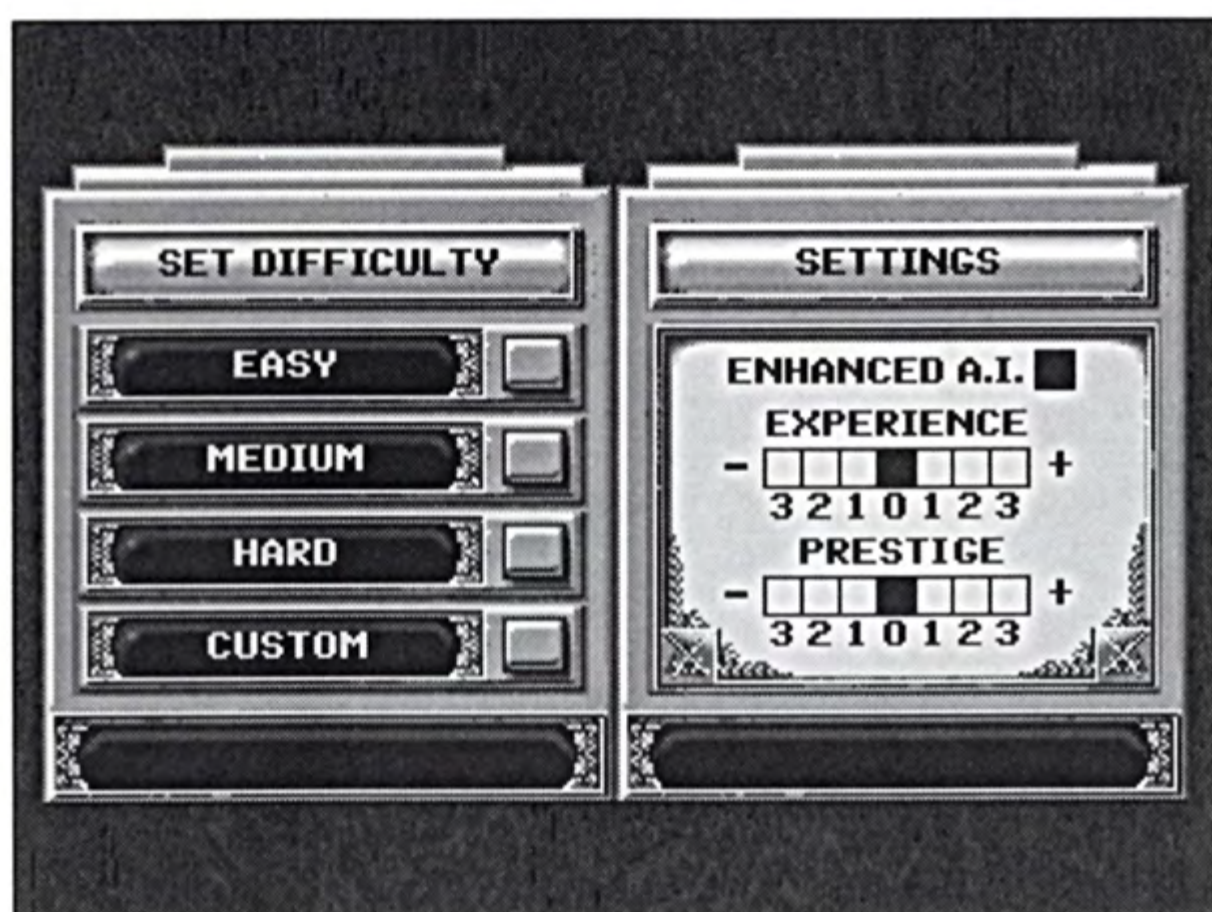

Press Exit to return to the Set Scenario menu. Once there, press the button next to Poland. The Set Scenario menu appears offering the choice of six scenarios. The currently selected scenario is listed in the panel centered at the top of the menu. The scenario description is in the large box and the six other scenario choices are listed at the bottom of the menu. The ? button in the lower right corner of the scenario description box opens a window with the scenario briefing.

choices are listed at the bottom of the menu. The ? button in the lower right corner of the scenario description box opens a window with the scenario briefing.



From the Set Scenario menu press Exit to return to the Set Scenario menu. With the settings on EASY for difficulty and Poland for the scenario, press the Start button to begin play.

Once chosen, the title screen of the scenario appears and displays the turn number, the date, the current weather, and the number of turns remaining.

Press any button to proceed beyond the title screen of the scenario and start your first turn. The Tactical Map, which represents the battlefield, appears in the main view. The game begins with the Unit Information preference turned on. As each unit is highlighted, important information is displayed in the corners of the screen. The lighter colored hexes are those visible to your troops. Your panzer units are gray and ready for battle.

## Game Turns

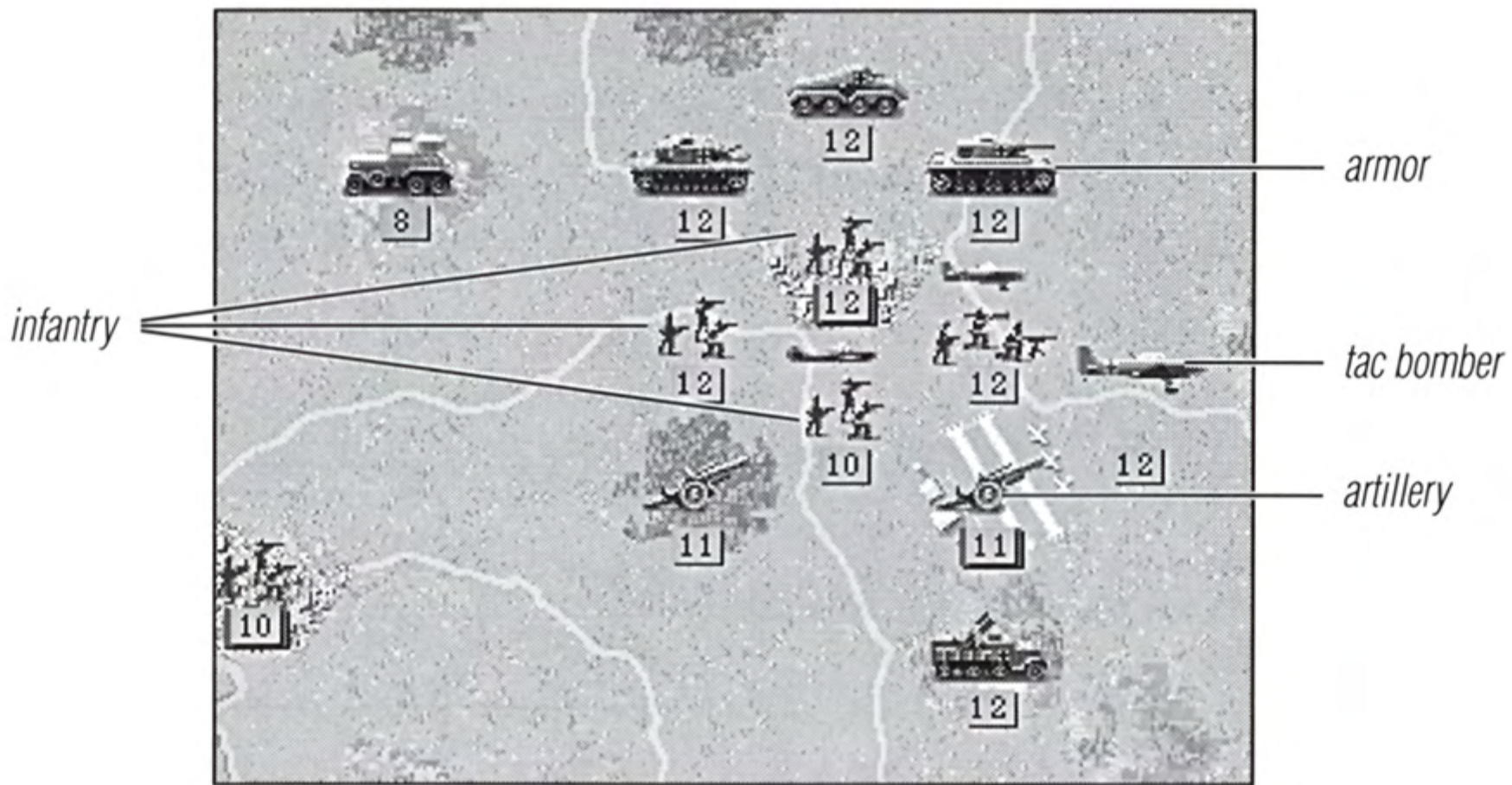

Each scenario in PANZER GENERAL is made up of a number of “turns.” In each turn you and your opponent are given a chance to perform many activities such as moving units, attacking enemy units, and resupplying units. When your turn is done and you have moved or given orders to all of your units, press the  $\circ$  button to open the Main Menu, then highlight and press the End button. Afterward, the enemy moves its units and completes its turn.

Highlight any German unit and press the  $\times$  button to make it ready for orders. On the map the lighter colored hexes are the hexes that the selected unit can move to. The unit’s statistics are shown in the corners of the screen. Be aware that an active unit cannot move to a hex occupied by another unit (unless one is an air unit and the other is a ground or naval unit).

Press the  $\square$  button to drop the active unit without taking any action.

With the Unit Information preference on, highlight and activate other units to see their summary information. You may also use the highlight to view the statistics of visible enemy units. Press the Unit Information Mode button on the Unit Menu to turn this preference off.

For now, press the  $\square$  button to drop a selected unit and press  $\circ$  to go to the Main Menu.

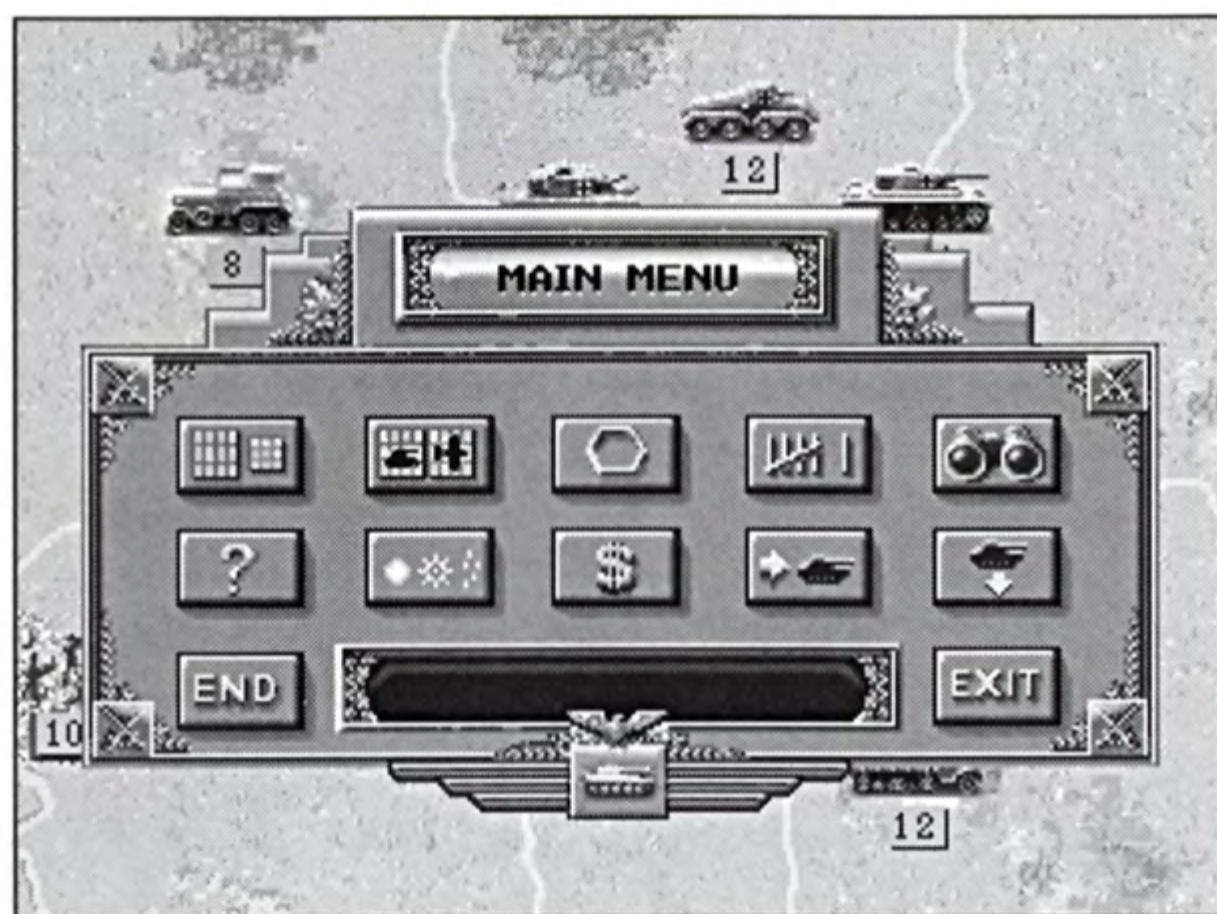

Notice that when you highlight a menu button, that button's function is displayed in the text display at the bottom of the menu. Use this feature to verify the function of menu buttons until you are familiar with them.

From the Main Menu, simply press the  $\circ$  button, or highlight and press the ? button,

to go to the Options Menu. Then highlight and press Turn Weather On/Off button so your first game is unaffected by bad weather.

**Note:** If you find the going difficult, a tactic you can use versus the computer is to choose Hidden Units Off at the beginning of every turn, then switch it "on" before you end each turn. That way you get to see the enemy, but when the enemy moves, he can't see you! As you become a more accomplished general, however, you may feel that defeating your enemy on honorable terms is more appropriate and you may choose not to use this feature.

Press the  $\circ$  button to go to the Main Menu. You are now ready to begin the Poland scenario.

---

### *Remember that in PANZER GENERAL...*

- ◆ *The  $\times$  button activates units and controls the various choices that you can make for an active unit.*
  - ◆ *The  $\circ$  button takes you from the Tactical Map to one of the many menus where you can set preferences and issue commands.*
  - ◆ *The  $\Delta$  button, pressed with the Previous or Next buttons, controls the zoom.*
  - ◆ *The  $\square$  button used by itself drops the currently active unit. The  $\square$  button also returns to play from any menu without implementing any changes.*
- 

## **Battle Plan**

Although a variety of battle plans can be successful in PANZER GENERAL scenarios, the following is a sound plan for "Poland," the first scenario of the 1939 campaign. The date is September 1, 1939 and your army's orders are to conquer the enemy with a lightning fast attack, a "blitzkrieg." In ten days they must capture the cities of Lodz and Kutno.

## *View Strategic Map*

As the soon-to-be-great (or greatest!) Panzer General, it is always a good idea to start every battle by viewing the Strategic Map of the battleground and formulating a battle plan. You can view the Strategic Map one of two ways. The first way is to switch to the Main Menu

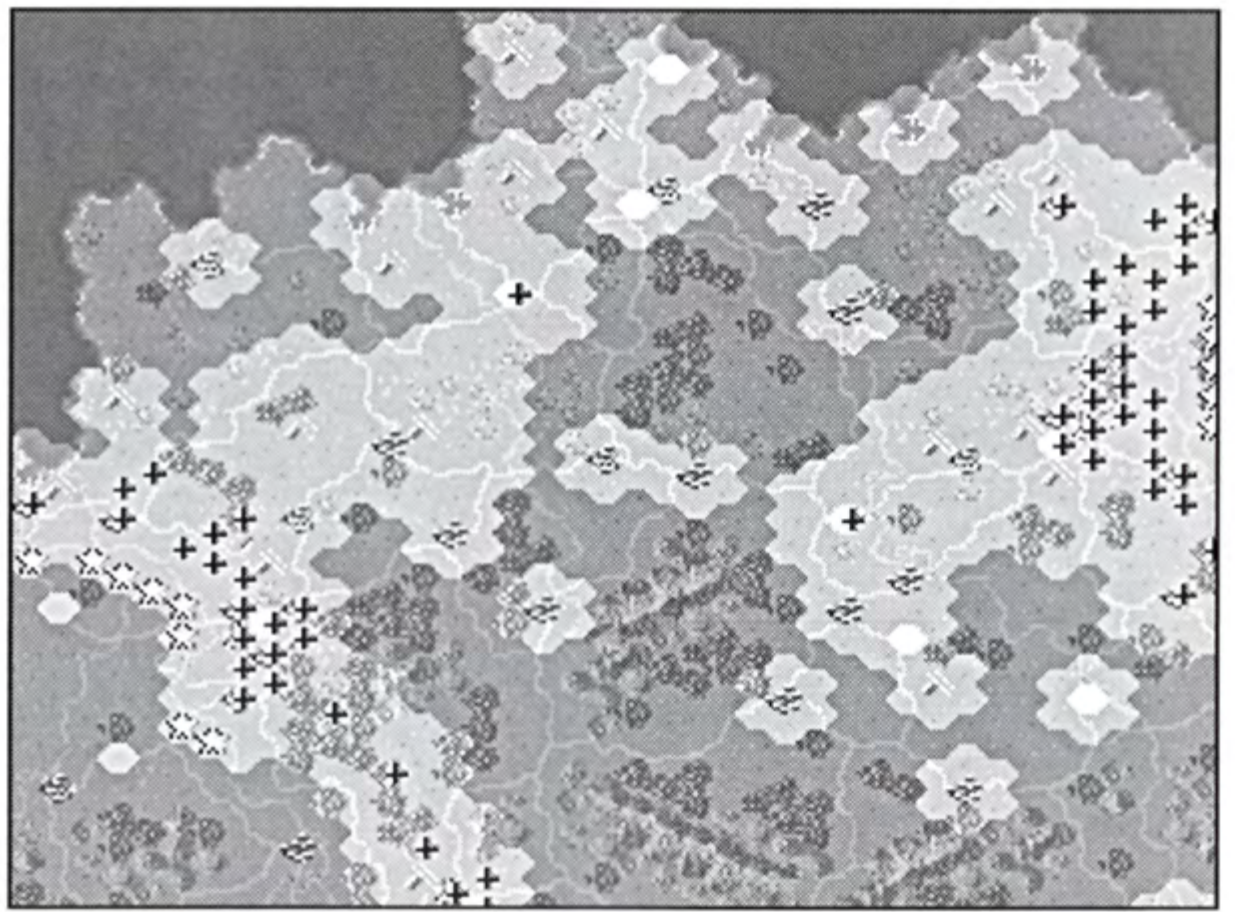

using the  $\circ$  button and press View Strategic Map button; or you can zoom out using the  $\Delta$  and Next buttons, and then press the  $\Delta$  button. A map appears which displays the entire battlefield: your Axis units with black German crosses, Allied forces with gold stars, and your victory objectives outlined in gold. Green outlined hexes are objectives which you have already won and must be held throughout the battle. It may be necessary to use the directional buttons while pressing the  $\Delta$  button to scroll around some of the larger campaign maps.

To view a portion of the map up close, press any button to return to the Tactical Map, or press the  $\Delta$  button while pressing the Previous button to zoom in. The view zooms in until the screen becomes the Tactical Map. To see the rest of the Tactical Map in this view, use the directional buttons to shift the map in the direction you wish to move. The screen scrolls in that direction until the farthest edge of the map is reached.

## *Divide and Conquer*

As a Panzer General you have been trained to strike swiftly in order to capture your objectives with armored spearheads, surround slow-moving enemy defenders, and crush them with your following infantry and artillery. Your battle plan therefore focuses on organizing your forces into flexible, combined-arms battlegroups, each aimed at a specific objective. Enemy forces in non-critical sectors can be ignored or dispatched with small detachments.

In this battle, your most effective plan is to divide your units into two battlegroups, one a northern attack force to take the cities of Kalisz and Kutno and the other a southern attack force to take the city of Lodz. Other cities earn you additional prestige but cost you more than they are worth if they delay your seizure of the objectives you have been ordered to take within the time you have been given.



*Be sure to reconnoiter the attack area well. Spotting is important!*

The battle plans for each battlegroup and their turn-by-turn implementation are described below.

- ◆ Battlegroup North should include 2 tank units, 3 infantry units, and an artillery unit towed by a truck. After defeating the 10th Polish Cavalry unit, the battlegroup is to quickly besiege and capture the city of Kalisz. With newly-gained prestige, another tank unit should be added to the force as it moves on to crush enemy tank units, cross the Warta river, and then lay siege to the city of Kutno.
- ◆ Battlegroup South should include one tank unit, 2 infantry units, an artillery unit with truck-transport which you should purchase in the first turn, and several infantry units with transport capability. This battlegroup is to head east across the Warta River, bypass the cities of Radomsko to the south and Ozorkow to the north, and besiege the heavily defended city of Lodz.

Cities other than Lodz and Kutno are secondary to your battle objectives and should only be attacked if in the direct path of your units (like Kalisz). In later scenarios, however, you can risk units against other cities to gain more prestige points.

---

## ***Prestige Points***

*Prestige rather than money is the medium of exchange in PANZER GENERAL. Prestige points represent the influence you have earned with the high command by taking and holding cities, destroying enemy units, and winning battles as quickly and decisively as possible. In the same manner, however, losing cities, losing units, and losing battles costs you prestige.*

---

## ◆ *Turn 1*

### **Battlegroup North**

Your orders are to attack the 10th Polish Cavalry unit with tank units, then with infantry units.

In this scenario, it is best to lead attacks versus enemy infantry and artillery units in clear terrain with tanks first and follow up with infantry.

Units that have not acted are indicated by the word *Ready* under the name of the unit in the upper left corner of the screen. This allows you to easily see which units you have moved and which you have not.

### **Movement**

Highlight and press *x* on a tank unit to activate it for movement. A black hex border marks the currently active unit. Each unit has a movement point allowance per turn that is spent as it moves. The number of movement points it costs to enter each hex depends on the terrain entered. It takes a unit's full turn to enter a river hex except where there is a bridge. The hexes to which a selected unit can move are lighter colored. In *PANZER GENERAL*, most units can both move and attack in their turn. For this scenario, you need to know that tanks and infantry can attack either before or after moving, but artillery can only attack before moving.

Move the highlight and press the *x* button when you reach the hex you want the unit to move to.

When moving a unit, and before selecting another unit to be moved, you can cancel your move by immediately pressing the *Abort Move* button on the Unit Menu. In effect, *Abort Move* returns the status of your unit to the pre-order phase, and it can still move, resupply, etc. This is useful in case you change your mind about that unit's move or wish to move another unit first.

Keep in mind that once a unit has moved and you activate another unit, you cannot go back except to look at unit statistics.

### **Attack**

To attack, move the tank unit to a lighted hex adjacent to an enemy unit. If at this time you are concerned about which enemy units are appropriate to attack, the highlight becomes a set of red cross-hairs when over enemy units which are appropriate targets. The expected losses appear to either side of the potential target. The number under the eagle icon is the losses projected for the Axis force (your unit), and the number under the star is the projected losses for the Allied unit. Keep in mind that these are projected losses; they may not be the same in actual battle! When you decide to attack, press the *x* button when the red cross-hairs are over the enemy unit.

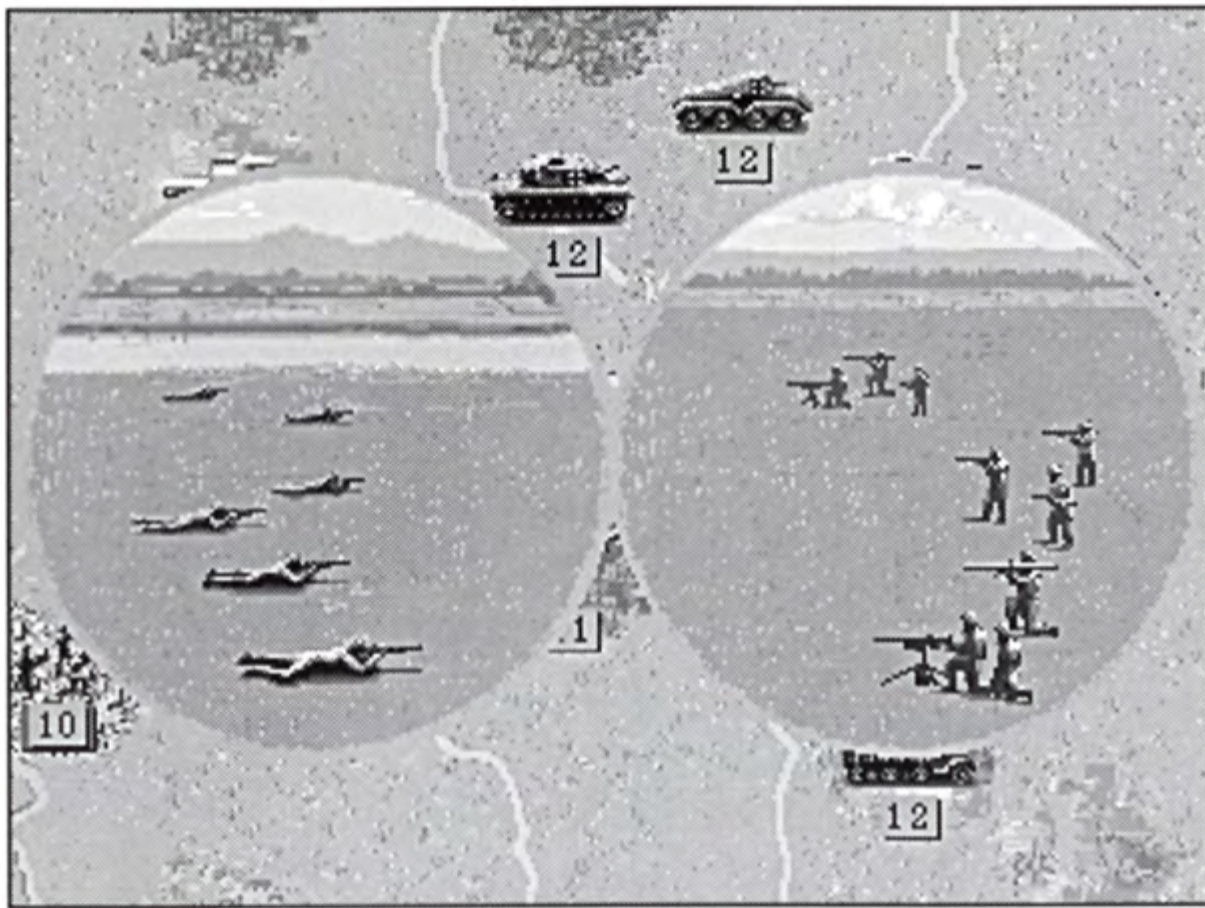

You cannot attack with a unit after another unit has been activated to move.

As the battle ensues, unit losses are indicated on the unit strength flag underneath each unit, and battle details are listed on a bar that appears at the bottom of the screen.

Use another tank unit to attack the 10th Polish Cavalry, then attack (if possible) with one or two infantry units.

Once the 10th Polish Cavalry unit is eliminated, or retreats, try to move the artillery unit into its transport (truck) and up to the northern tip of the forest. If you cannot move it this turn, try to do so next turn.

### Mount onto Transport

To load the artillery unit into its transport, highlight the unit and press the  $\times$  button to activate the unit then press the  $\circ$  button to open the Unit Menu. The Mount button has a truck with a two-ended arrow pointing at it. Press the Mount button. Once the unit is mounted, the unit icon changes to its transport type, in this case a truck. The number of lighter-colored hexes increase, which indicates the mounted unit's movement range.

Units in transports do not have high defensive capabilities. If at all possible, first dismount units before attacking the enemy.

**Note:** In later scenarios, if you want to purchase a transport for an infantry unit, you must move the unit into a friendly city hex and choose Upgrade from the unit menu on the following turn.

Move any other Battlegroup North units (totaling two tanks and three infantry) within two hexes of Kalisz to prepare for the siege next turn.

### Battlegroup South

Your orders are to move a tank unit as far east toward the Warta river as possible, followed by infantry units in transports and an artillery unit you purchase. Leave one infantry unit to protect the city of Breslau. If no transport is available for an infantry unit, use it to flank the other units and provide quick defense.

Once again, in this scenario it is best to lead attacks versus enemy infantry or cavalry with a tank first and infantry following after.

*Once destroyed, an experienced core unit can never be replaced.*



### Purchase New Units

To ensure success, you should purchase an artillery unit with transport capability. To get another artillery unit you use your influence with the high command, or "Prestige Points," to purchase a unit.

Press the Purchase Unit button from the Main Menu and the Purchase Type menu

appears. The Purchase Type menu displays unit classes available with a green light and units which are above the cost of your current prestige points are indicated by a red light. Units which are not yet available for historical reasons are also indicated with a red light. Press the Artillery button to see the available artillery class units.

The Purchase Screen shows: the unit name, the type of unit, up to four available types of artillery units, the statistics of the currently selected unit type, and buttons to scroll through the various units of that type. The cost for the unit is the figure with the dollar sign (\$) next to it in the Defense column at the top of the screen. The total number of units which are available is shown in the upper right corner. The ? button next to the Prestige Point total opens the Glossary, where information about this unit type can be found.



When you press the button which represents the 7.5 leFk 16nA artillery unit, the unit's statistics appear in the table at the top right corner of the screen. This unit (more become available in the future) costs 84 prestige points. There are four other rectangular buttons:



- ◆ The top button displays the class of unit currently being viewed; in other words, if the current unit type is artillery, the button reads Artillery. Pressing this button, however, changes to the next class of unit listed on the Purchase Type menu.
- ◆ Transport — Switches to show the available types of transport, including statistics and cost.
- ◆ Purchase — Deducts the unit's cost from your prestige points and exits to the Tactical Map so you can deploy the unit.
- ◆ Exit — Returns to the Tactical Map without making a purchase.

If transport is available for a unit, a green light appears next to the Transport button. Statistics for this transport type can be seen by pressing the Transport button. There are two choices of transport for your artillery unit: either the Opel truck transport, or the SPW half-tracked transport. Highlight one or the other and press  $\times$  to choose it and view its statistics. The new total cost for both the unit and the transport appears in the "Cost" box above the statistics.

Press the Purchase button to confirm the purchase. If you want to cancel a purchase before placing the unit on the map, press the  $\square$  button. **Note:** Once a unit has been deployed, there is no going back!

Be aware that the units you purchase must be placed in or adjacent to friendly or captured cities where there is no adjacent hex occupied by an enemy. Your new artillery unit should be placed near the city of Breslau. Move the highlight to one of these hexes and press  $\times$  to place the unit. Next turn you should load it onto a transport and move it along with the southern attack force.

From the Main Menu, press the End button, and answer Yes to confirm the end of your turn.

## ◆ *Turn 2*

### **Battlegroup North**

Your advance in Turn 1 should have placed you in position to attack and capture the city of Kalisz. After you do so, purchase a new tank with your newly-won prestige.

### **Dismount**

Activate the artillery transport in the forest and press Dismount from the Unit Menu. Place the highlight over Kalisz and red cross-hairs appear. Even if the casualties the artillery can inflict are minimal, when you attack the city the entrenchment level of the defending Polish infantry is weakened. Since the artillery unit is making a ranged attack, it suffers no risk of losses by bombarding. Fire by pressing the  $\times$  button. After shooting, you can choose to move the artillery one hex while remaining deployed or Mount it to move it to another location. Remember that units mounted in trucks or half-tracks fight poorly. Do not move the artillery next to Kalisz as it may block your other units and it can bombard just as well from 2 hexes away. If you choose not to mount the artillery unit, press the Next button to end its turn.

Beware of cities defended by infantry with artillery adjacent to them, as the artillery can support the infantry by shooting at your units as they attack the infantry. If an artillery unit is adjacent to Kalisz, try to attack and destroy, drive away, or at least weaken the artillery unit before assaulting the city. This should not be hard since artillery units are vulnerable to attacks by tanks and infantry.

When you capture Kalisz, press the Purchase Unit button to purchase a new tank unit (a Pz III or Pz IID is recommended) with your accumulated prestige points and place it near the city. If there are no enemy units adjacent to Kalisz, lighter colored hexes indicate you may deploy the unit there. If you want to cancel a purchase before the unit is deployed, press the  $\square$  button.

If you have not captured Kalisz, repeat the attack next turn.

### **Battlegroup South**

Your goal is to cross the Warta River, blitz through any enemy units which may have approached, and continue on to Lodz. Move the tank leading the Battlegroup across the river with the infantry in trucks behind. Be sure to Mount the artillery unit you purchased at Breslau and move it as far east as possible.

## Go to Unit

If you find that you are forgetting which units have moved and which have not, press the Go To Unit button on the Main Menu. A display shows units which have moved with a red light and units which are ready for orders with a green light. If the Unit Information Mode is on, the words "Ready" or "Moved" will appear in the upper left corner when you activate a unit to indicate that the unit has or has not moved. The ? button next to the Prestige Point display opens the Glossary, where information about this unit type can be found.

After you have moved all of your units, press  $\circ$  to open the Main Menu, press the End button, and answer "Yes," to confirm the end of your turn.

## ◆ Turn 3

### Battlegroup North

Continue to move tank units northeast across the river towards Kutno. Attack enemy artillery and armored vehicles, as these can do serious damage to your infantry as they follow behind your tanks. Leave an infantry unit which has suffered the most behind in or near Kalisz as a garrison and replace its losses.

Pace yourself and beware of the urge to launch a premature attack on Kutno. First, clear away any enemy units near the city which might interfere with your attack, then bombard the city with your artillery while your infantry move into position to attack.

### Replacements

You may have suffered serious casualties in some units up to this point. It is good practice to promptly reinforce units with low strengths by highlighting them and pressing the Replacements button on the Unit Menu. A unit can receive replacements only if it does not take any other action during the turn (except mounting or dismounting). Units which have fallen below 8 strength points should receive replacements. Strengthening your infantry before the assault on Kutno may delay the attack, but it gives you more time to drive away nearby enemy units and allows you to deploy your artillery in range of the city to commence a bombardment. Keep in mind that enemy units adjacent to the unit that is getting replacements reduce or even prevent the replacements from arriving.

Once the unit has been supplied, the view returns to the Tactical Map with that unit still active. Press Next to drop that unit and activate the next one. Remember that providing any unit with supplies, replacements or elite replacements ends that unit's turn.

## **Battlegroup South**

Use your tank unit to attack enemy cavalry, particularly enemy tank units you have spotted. Because infantry are vulnerable while mounted in trucks, Dismount them at the beginning of the turn and advance them towards Lodz on foot. Move your artillery, if possible, within a 2-hex range of Lodz to allow it to dismount next turn and begin a bombardment. Since they are vulnerable to any enemy attacks, take care to put tank or infantry units between any enemy units nearby.

### **◆ Turn 4**

## **Battlegroup North**

You may want to build another infantry unit near Kalisz to allow the garrison unit to help the continuing attack on Kutno.

## **Battlegroup South**

Bombard Lodz for several turns with artillery before sending in your infantry. This avoids the risk of troops being massacred if the Poles put up a “rugged defense.” Do not divert units from the effort against Lodz by attempting to attack the nearby cities of Ozorkow or Brzeziny. Once Lodz is taken, you may be able to capture another city.

### **◆ Turns 5-10**

## **Supply Units**

Be aware that tank units and units with transport can run out of fuel and all units can run out of ammo. To avoid this, units can use their turn to resupply by highlighting them and pressing Supply Unit on the Unit Menu. Units cannot resupply when adjacent to enemy units, unless in a city, airfield, or port. Units that receive Replacements are automatically resupplied at the same time.

Battlegroup North should be able to take Kutno easily within a turn or two. Be wary, however, of enemy units attacking from the city of Posen in the west. They can move towards Kutno, Kalisz, or your base at Breslau. Detaching a unit to guard Breslau ensures against this risk. If Kutno falls immediately, you can send forces west towards Posen or south to help in the attack on Lodz, which may take a little longer since Battlegroup South is somewhat weaker. When both Kutno and Lodz have been taken, the scenario immediately ends.



*The proper use of roads is most important when using wheeled vehicles — they move twice as fast.*

## ***After the Battle***

### **Save or Exit**

After the battle you may inspect the battlefield before choosing to Save or Exit your game. Don't worry if your first experience in the Poland scenario ended with an Allied victory. PANZER GENERAL is designed to be thought-provoking and challenging — there is more than one approach to victory. War is often as much a battle against time and terrain as it is against the enemy, and the best-laid plans can be defeated by bad weather, rugged defense, or just plain bad luck.

You now know the basics of playing PANZER GENERAL. The interface is highly intuitive and you may wish to simply continue playing or read through the manual for more detailed information about the game mechanics and for tactical advice.

## Tactics Checklist

Remember the following tactics in any scenario you play:

- ◆ When a unit attacks, it uses one unit of ammo. When it's out of ammo, it can't attack, and must resupply (when not adjacent to an enemy unit).
- ◆ Cities secondary to your battle objectives should only be attacked if they are in the direct path of your units. On the other hand, in later scenarios, risking units to capture other cities gains you more prestige points.
- ◆ All units have movement points which are expended as the unit moves. Each hex costs a number of movement points, based on the type of terrain entered. When you activate a unit, the lighter colored hexes which appear are where the unit may legally move. When you move units across rivers without using roads or crossings, all movement points for those units are used.
- ◆ Check your units' ammo frequently, and if low, resupply.
- ◆ Replace weakened units even when they are close to enemy positions. It's better to suffer loss than annihilation.
- ◆ Mount units which have transports whenever possible, but be sure there is armored protection close by. A given unit can only embark on a naval transport at a port or coastal city. Only infantry, light artillery, and light anti-tank units may use air transports at an airfield. Embarking or disembarking a unit can only be done at the beginning of the unit's turn. Naval transport units can disembark into an adjacent land square, air transport can only disembark at airports, while paratroopers can disembark anywhere. Disembarking ends the unit's turn.
- ◆ Replacements, Disband, Upgrade, and Elite Replacements orders can only be given at the beginning of the unit's turn. When these options are chosen, the unit's turn ends.
- ◆ Abort Move returns a unit to pre-order status, and cannot be used after the unit has acted by attacking, resupplying, receiving replacements, or by moving adjacent to hidden enemy units. If you press the Next button after moving a unit, it ends that unit's turn.
- ◆ Keep in mind that in the second battle of the 1939 campaign (the battle of Warsaw), aircraft units are available and are necessary for an Axis success.
- ◆ Even though the "expected losses" may not be in your favor, you may still need to sacrifice some of your unit strength to achieve your goals. This is especially important when attacking enemy units with high entrenchment levels. Even though the attack may not be effective, the enemy entrenchment level lowers at least one point, and is more vulnerable the next turn.
- ◆ The enemy cannot place newly-purchased units around its cities if you have a unit adjacent to the city.

## STARTING A NEW GAME

### Start Game Menu

The Start Game menu gives you a choice to begin a single Scenario, start a Campaign, Load a saved game or view Information. For information about starting a scenario, see the “Setting Preferences” section on page 3.

### Starting A Campaign Game

Campaign games are made up of a series of scenarios which represent the operations conducted over a period of time during World War II. You begin with a group of core units, which are carried over from scenario to scenario, and are also given command over other units that headquarters has made available. You can supplement these forces with units purchased using prestige points which become part of your core force.

#### *Choosing a Campaign*

The Campaign button on the Start Game menu opens the Campaign Selection menu. Highlighting and pressing OKAY starts the campaign, while pressing the Exit button returns you to the Start Game menu. See “Continuing a Campaign Game” on page 32 for details.

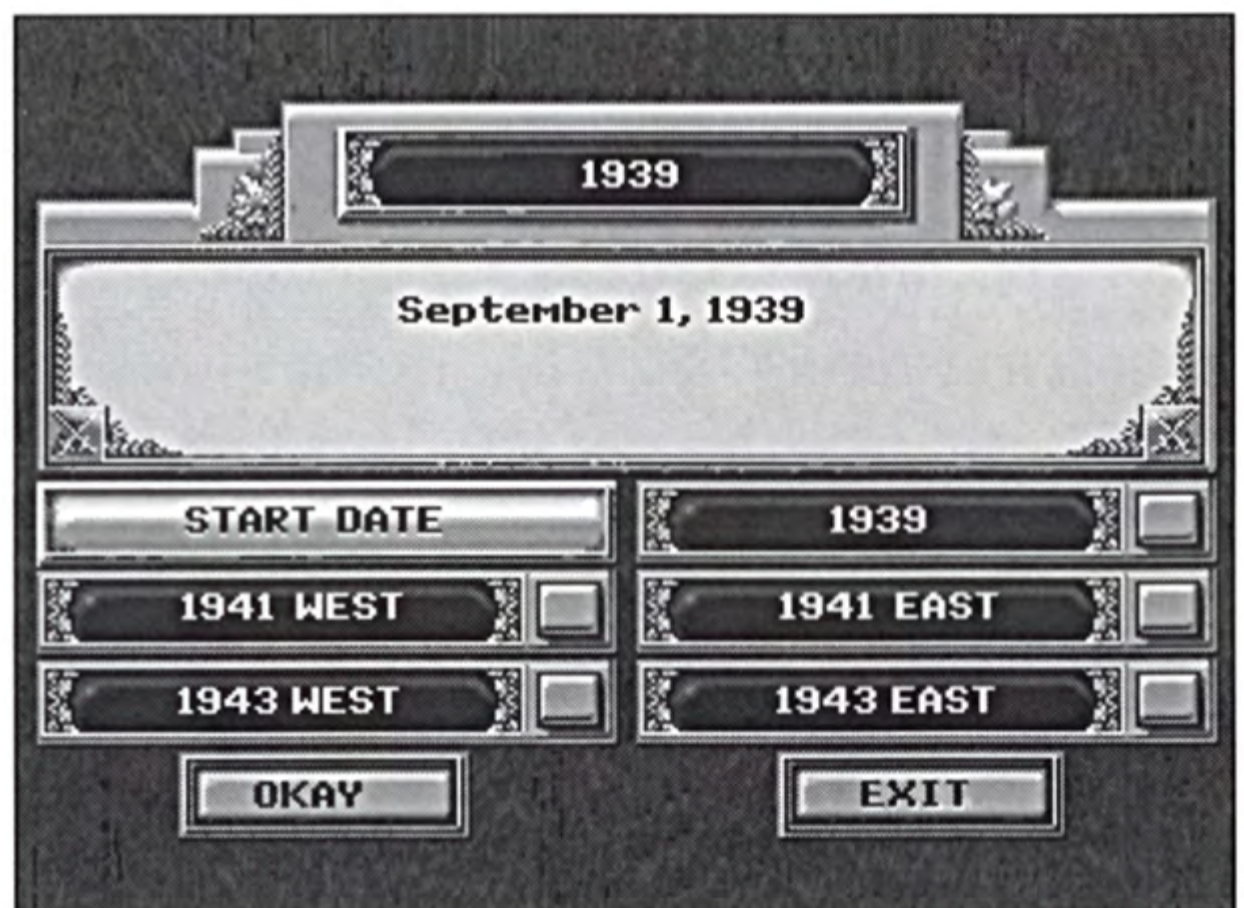

### Loading a Saved Game

**Note:** Only PlayStation systems equipped with memory cards will be able to save games. Pressing the Load button presents the Load Menu where there are four save positions. Each game has been saved using the name of the scenario and the turn number. Once you have selected a save position, press the  $\times$  button to resume play. Pressing the  $\square$  button returns to the Start Menu without loading.

### Information

The Information Button opens a menu offering four new choices: Glossary, Help, Victory Rating, and Campaign History. Glossary entries contain useful information regarding specific unit types. The Victory Rating shows your top ten scores for scenarios you have won. The Campaign History shows the results of your most recently completed campaign. **Note:** The Victory Rating and Campaign History options will only function on PlayStations equipped with memory cards. Help displays designers notes, tips for play and any important details that couldn't make it into this manual.

## MENUS

There are three basic menus in PANZER GENERAL: the Main Menu, the Options Menu, and the Unit Menu. The following menu options are available on each menu as buttons. These buttons change based on the active unit and what options are available. Unavailable options appear pressed-down and cannot be used. **Note:** Buttons which are referred to as “toggles” do not return to the Tactical Map even though they may make a change to it. Pressing the Exit or the □ button returns you to the Tactical Map.

### Main Menu

The Main Menu is the menu you use most during the game. From its selections you are able to change views of the battle area, choose views of either ground or air units, view unit statistics, change the conditions of the battlefield, purchase new units and equipment, and go to units waiting for orders.

Highlight menu buttons by moving across them with the directional buttons, and press the x button to “press” them. Highlight and press the ? button or use the ○ button to toggle between the Main Menu and the Options Menu.

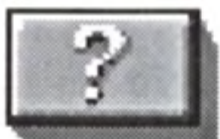

**Go to Options Menu:** displays game options for you to choose from.



**View Strategic Map:** toggles between the Strategic Map and the closest zoom mode. **Note:** hexes with stacked units will show either air or ground units depending on which mode has been set using the Stacked Air/Ground Units button.





**Stacked Air/Ground Units:** toggles between viewing your land and air forces. When both a surface and air unit occupy the same hex, the view determines which one of the icons is large and which is small on the Tactical Map. The large icon is the one that you activate when you highlight it and press x.





 **Turn Hexsides On/Off:** adds or removes the hex grid from the map.

 **Show Score:** displays a “casualties” list showing the number of unit classes the Axis and the Allies have lost in the current scenario or campaign. The screen displays scenario losses, and in a campaign game an additional screen displays campaign losses.

 **Turn Information Mode On/Off:** toggles the unit information overlay on or off. The Unit Information mode displays detailed information about the current unit in the corners of the Tactical Map screen. This information is important in evaluating the unit’s combat capabilities. In

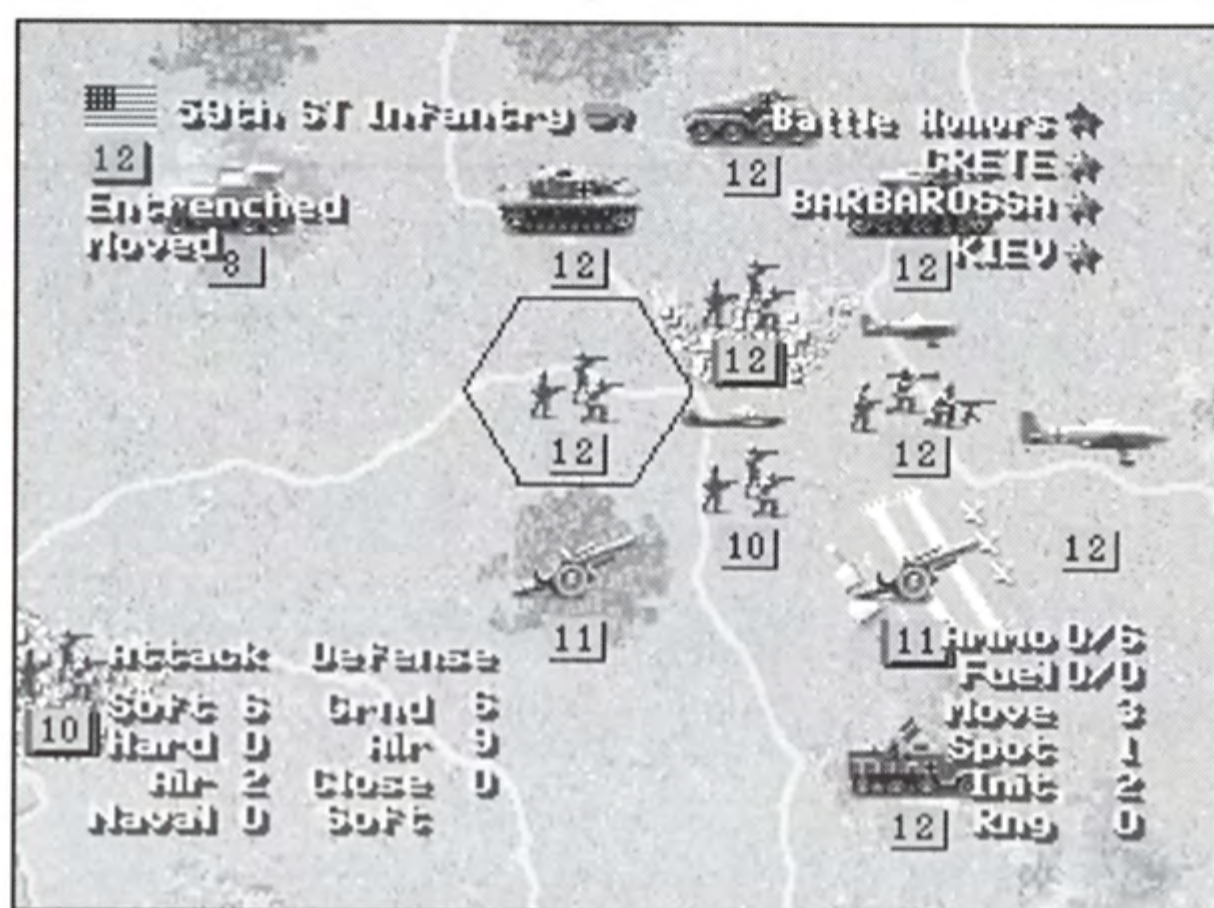

campaign scenarios this screen also displays battle honors won by the unit for distinguished performance in particular battles.

When unit information is on, statistics for the active unit appear in the corners of the screen. The upper left corner shows the unit nationality; name; type; attached transport type, if any; strength; entrenchment level; and move status. The upper right corner shows the unit’s Battle Honors and Experience. The lower left corner shows the unit’s attack and defense ratings. The lower right corner shows the unit’s supply status, remaining movement, spotting range, initiative and range. For a detailed description of these statistics, please see the “Unit Class Descriptions” section on page 38.

 **Weather Report:** opens a window that shows you the weather for the current turn and the next turn. Press Exit to return to the game.

 **Purchase Unit:** allows you to add reinforcements. These are added to the core army if more core units are available, or to auxiliary forces if only auxiliary units are available. Purchase units with prestige points and place them in or adjacent to friendly cities (if land units) and friendly airfields (if air units). You cannot purchase ships. See the “Prestige Points” section of this manual on page 34 for more information.

 **Go to Unit:** displays a screen similar to the Purchase Units menu. This screen shows statistics for all of your units and indicates the units which are waiting for orders with a green light and those that have already acted with a red light. Pressing the Go To Unit button in the upper left corner switches the view to the currently selected unit. Pressing the Next or Previous buttons scrolls through the available units.

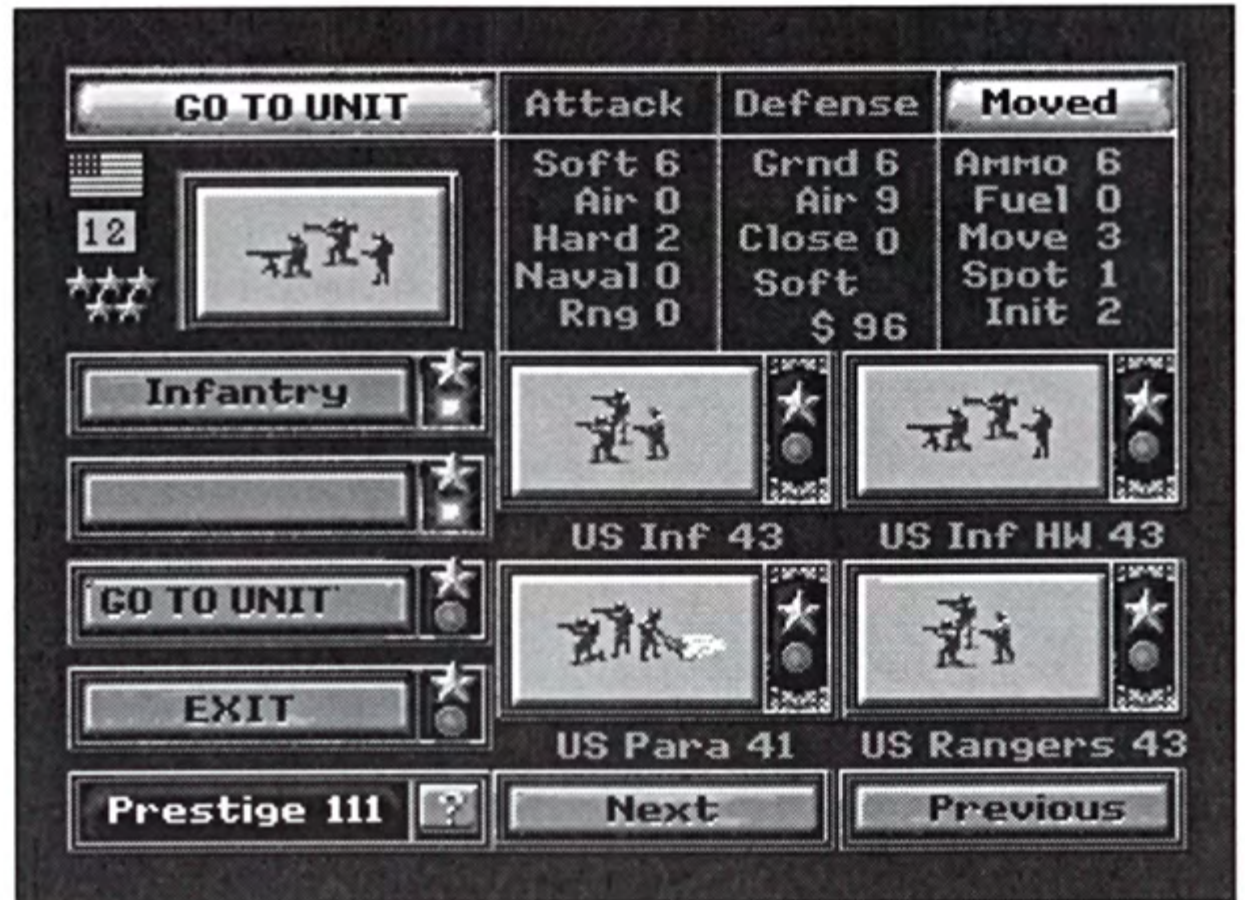

 **End Turn:** ends your turn and proceeds to your opponent's turn. You will be asked to confirm that you wish to end your turn.

 **Exit:** returns to the Tactical Map.

## Options Menu

The Options Menu provides an extended range of game preferences for you to choose from. Buttons referred to as "toggles" do not return to the game directly.

 **Set Difficulty:** opens the Set Difficulty Menu where levels can be to EASY, MEDIUM, HARD, or CUSTOM. CUSTOM difficulty allows you to adjust enemy experience and prestige levels separately, and also allows you to turn off the computer's "Artificial Intelligence" (AI).













 **Hidden Units On/Off:** changes the view on the Tactical Map of units, by either using your units' spotting levels, or by displaying all enemy units at once.

 **Turn Animation On/Off:** toggles combat animations. Turning the animation off makes the game move more quickly. Animations in progress can be ended at any time by pressing any button.

 **Turn Weather On/Off:** toggles realistic weather conditions.



*Coordinated use of infantry and armored units is the key to successful offensives.*

- 
**Turn Supply On/Off:** toggles the supply rules on and off.
- 
**Music Volume:** opens a window with On/Off controls and a volume control for adjusting the volume.
- 
**Sound Effects Control:** opens a window with On/Off controls and a volume control for adjusting the volume.
- 
**Hide/Show Unit Strengths:** hides or shows the view of each unit's strength.
- 
**Hide/Show Computer Move:** hides or shows the computer's moves. Even if this is on, the computer's attacks are still shown.
- 
**Load/Save Game:** ends the current battle and has buttons which allow you to Save your game, Load a saved game, press Exit to return to the Tactical Map, or Quit which restarts the game. To end your play session, simply turn the power off and remove the CD from the game unit.
- 
**Turn On/Off Speed Move:** toggles the speed at which enemy moves are displayed.
- 
**Show Score:** displays a "casualties" list showing the number of unit classes the Axis and the Allies have lost in the current scenario or campaign. The screen displays scenario losses, and in a campaign game an additional screen displays campaign losses.
- 
**M Go to Main Menu:** returns the view to Main Menu.
- 
**EXIT:** returns to the Tactical Map.

## Unit Menu

The Unit Menu appears when you highlight a unit during your turn and press the  $\circ$  button.

The Unit Menu provides options which are unique to the unit you have selected. You can choose to mount the unit if transport is available,

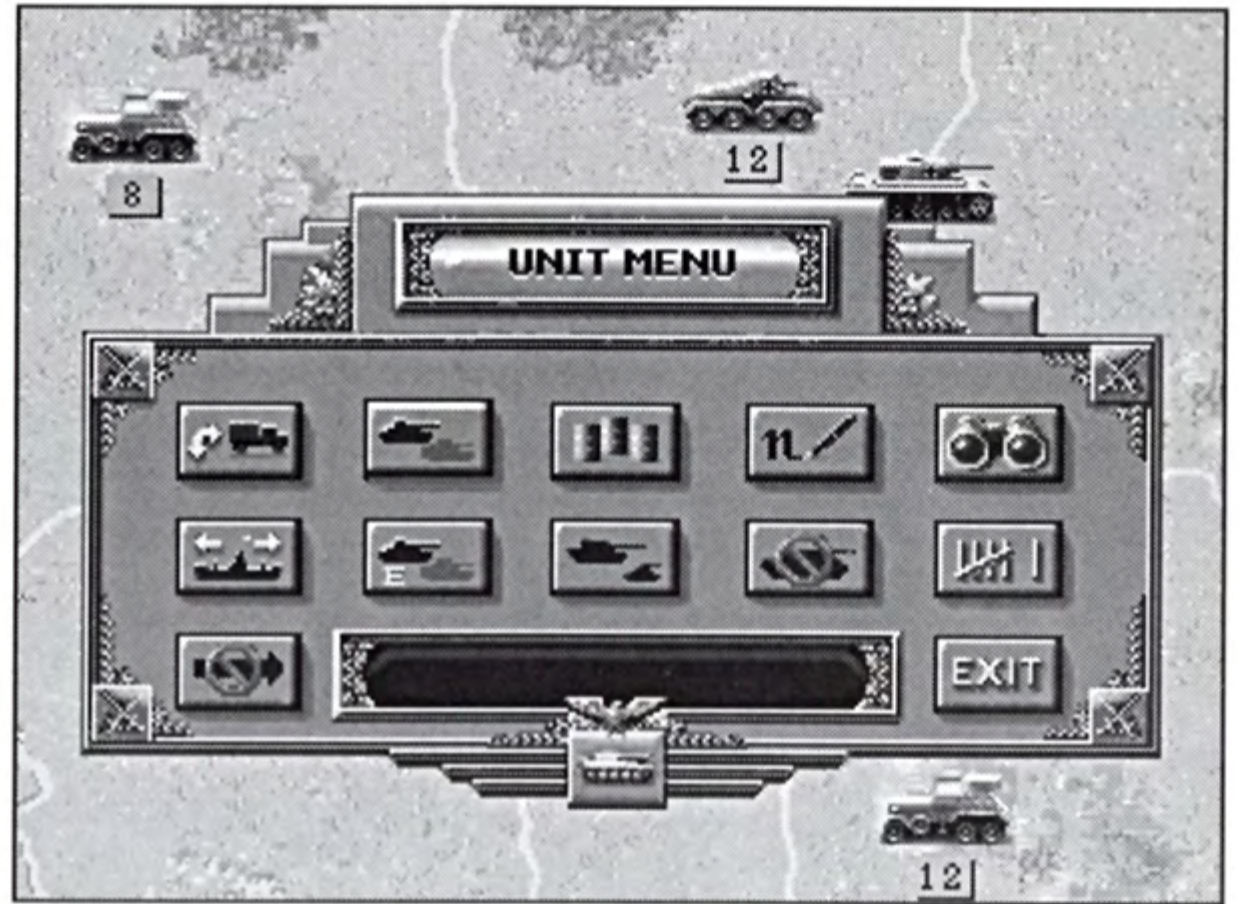

purchase replacements and upgrades, disband, give your unit a name, examine unit statistics, go to another unit, or resupply. Be aware, however, that some of these commands require the unit's entire turn to execute, so once selected, the unit cannot do anything else that turn.

 **Mount/Dismount:** allows a unit to be mounted for rapid transport if the unit includes organic transport. Mount units which have transport whenever possible, but be aware that mounted units make easy targets. This button also serves to dismount a mounted unit.

 **Replacements:** replace lost strength points and automatically resupply the unit as described under "Supply Unit" below. Replacements begin with zero experience which is averaged with the unit's current experience to generate a new experience level. This option ends the unit's turn. Units can get replacements anywhere, except that air units can receive replacements only when on a friendly airfield or carrier hex. A unit receives fewer replacements if one or two enemy units are adjacent. If three enemy units are adjacent, the unit cannot receive any replacements unless it is in a city. Bad weather and desert terrain also reduce replacements. Once replacements have been assigned, press Next to proceed to the next available unit.

 **Supply Unit:** re-supplies the selected unit with up to half its maximum capacity and takes one turn. Units receiving replacements automatically resupply. Adjacent enemy units prevent resupply except as part of receiving replacements. Snow and rain reduce resupply by 1/3. Desert terrain reduces the amount resupplied by 3/4, to a minimum of 1 ammo and 1 fuel. Once the unit has been resupplied, press Next to proceed to the next available unit.

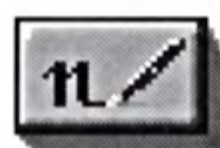

**Name Unit:** allows you to personalize unit names. These names remain in effect until the end of the scenario (or through the entire campaign if your PlayStation is equipped to save games). You may want, for example, to name units according to their capabilities or how you intend to organize them in battlegroups. Keep in mind that units are numbered consecutively by the computer in each scenario, thus slightly changing the names you choose.

Use the directional buttons to move the highlight over the letters used to create the name. The  $\circ$  button accepts the name and exits to the Unit Menu. The  $\times$  button accepts the highlighted letter. The Next button leaves a space and the Previous button deletes backwards. The  $\square$  button exits to the Unit Menu without renaming the unit.



**Unit Information Mode On/Off:** toggles the unit information overlay on or off. When unit information is on, statistics for the active unit appear in the corners of the screen. The upper left corner shows the unit nationality; name; type; attached transport type, if any; strength; entrenchment level; and move status. The upper right corner shows the unit's Battle Honors and Experience. The lower left corner shows the unit's attack and defense ratings. The lower right corner shows the unit's supply status, remaining movement, spotting range, initiative and range. For a detailed description of these statistics, please see the "Unit Class Descriptions" section on page 38.



**Embark/Disembark:** allows most units to use naval transport, and allows infantry, light artillery, and light anti-tank guns to use air transport. When embarking, the unit's icon is replaced by a sea or air transport icon. Units can only embark on naval transport at ports or coastal cities and on air transport at airfields. Embarking and disembarking units can only be done at the beginning of a unit's turn. Naval transports can disembark into an adjacent unoccupied land hex and air transports can only disembark at any unoccupied airfield. Paratroops may choose the hex the air transport is in or any adjacent land hex as their drop zone, and are subject to drifting from the selected drop zone. Disembarking ends the unit's turn.

When you attempt to embark a unit you must leave any organic transport behind. The Confirm Abandon window opens which shows the number of transport points available and requests confirmation that you wish to leave that unit's transport behind. Example: An infantry unit you wish to embark onto a plane and transport to a newly-won airport cannot take its truck or half-track with it onto the plane. Therefore, you must confirm the abandoning of the transport or use a unit without transport. Transports that are abandoned are lost.



## ***Unit Statistic Descriptions***

### **Current Ammo**

The amount of ammo the unit currently has. Avoid running out of ammo, since without it you cannot shoot at the enemy. Note that many rounds of ammo can be consumed in a single turn if a unit defends against several enemy attacks.

### **Current Fuel**

The amount of fuel the unit currently has. Avoid running out of fuel while adjacent to the enemy or you can be trapped and unable to resupply. Units that run out of fuel have their number of strength points halved for combat.

### **Maximum Fuel**

The maximum fuel capacity of the unit. For certain units this capacity also reflects susceptibility to breakdowns.

### **Maximum Ammo**

The maximum ammo capacity of the unit.

### **Entrenchment**

This unit's current total entrenchment level. All ground units can entrench, but at different rates. All terrain types have a base entrenchment level from 0-4 which ground units in that hex with lower entrenchment levels automatically obtain at the end of their turn. Units that have not moved are assumed to dig in each turn even if they attack, resupply, or perform some other action. Each turn the unit does not move, it digs in. Infantry is best at entrenching, and anti-aircraft and tanks are the worst. Units can entrench up to a maximum of 5 above the base entrenchment level for the terrain. If a unit moves out of the hex it loses all its entrenchment levels, so pick a good position before digging in.

Each attack on an entrenched unit, whether successful or not, reduces its entrenchment level by one level. Repeated attacks in a single turn can even reduce the entrenchment level below the base level for the terrain, thus facilitating further attacks during the same turn.

Base entrenchment levels are: 4 for fortifications; 3 for cities; 2 for forests, bocage (small fields bordered by hedgerows), and mountains; 1 for rough terrain and non-city port facilities; and 0 for everything else.

## **Experience / Battle Honors**

Each time a unit takes part in a combat it gains experience. The more successful it is in combat, the more experience it gains. An experience level is symbolized by a gold star in the unit's summary information. The maximum experience level a unit can achieve is 5. When two units fight, their relative experience levels affect who shoots first and determines relative casualties. Experience also determines overstrength size, reduces the risk of rugged defense, and modifies initiative. Units with 2 or 3 experience levels should be considered veteran troops and those with 4 or 5 levels elite troops. Elite replacements should be used to preserve the quality of veteran and elite units. Making veteran and elite units overstrength (see below) is valuable because they are better able to withstand and inflict casualties in combat.

Units that proceed from one scenario to another within a campaign game and achieve at least one experience level (one gold star) earn a Battle Honor for that campaign.

## **Strength**

Units begin with 10 strength points. Losses are suffered in strength points, and a unit reduced to 0 strength points is destroyed. Units with experience have their maximum strength increased by 1 per experience level, up to a maximum strength of 15 points at 5 experience levels. Units can add overstrength points at a rate of one per turn by selecting Elite Replacements. If you lose strength, rebuilding the unit to overstrength status must be done the same way. Overstrength units are very potent in battle.

## ***Unit Equipment Statistic Descriptions***

### **Class of Unit Equipment**

This indicates the unit class (tank, anti-tank, infantry, artillery, capital ship).

### **Cost**

The prestige point cost of building a new unit of this type.

### **Maximum Ammo**

The amount of ammunition the unit equipment begins with.

### **Maximum Fuel**

The amount of fuel the unit class begins with.

### **Spotting**

The range in hexes at which a unit can spot enemy units in fair weather.

### **Range**

The unit's shooting range in hexes.



**Initiative**

In combat, initiative, together with unit experience and the type of defender's terrain, influences whether or not the attacker or defender shoots first or both shoot simultaneously.

**Soft Attack**

The unit's attack value against "soft targets" such as infantry, trucks, and towed weapons. Units with highlighted strengths may not attack but may shoot back if attacked.

**Hard Attack**

The unit's attack value against "hard targets" such as tanks and half-tracks. Units with highlighted strengths may not attack but may shoot back if attacked.

**Air Attack**

The unit's attack value against air targets. Units with highlighted strengths may not attack but may shoot back if attacked.

**Naval Attack**

The unit's attack value against naval targets.

**Ground Defense**

The unit's defense value against attacks by land and naval units.

**Air Defense**

The unit's defense value against air units.

**Close Defense**

Units use their close defense value in "close assaults." When any unit attacks infantry which puts up a rugged defense, the attacking unit uses its close defense value. Units fighting infantry who are attacking into or defending a forest or city hex also use their close defense values. Since close defense values are usually less than ground defense values, this makes infantry more dangerous in non-clear terrain hexes.

**Target Type**

There are four target types: Soft, Hard, Air, and Naval. Each unit has a separate attack value against each type of target.

**Transport**

If a unit has organic transport, an icon of a truck or a half-track appears next to the unit name. The unit's statistics change when mounted to those of the unit's transport.

## GAME PLAY

### The Tactical Map

The Tactical Map represents the area where all movement and combat takes place. This is viewed as either a scrolling close-up view map or a single overall Strategic View map. If playing with two players, one controls all Axis forces and the other controls all Allied forces. The campaign games are for a single player who controls the Axis forces.

The scale varies from region to region, as does the actual size of the units represented. The maximum number of units allowed in a hex is one land or sea unit and one air unit.

Unless toggled with their respective menu switches, hidden enemy units and sudden changes in weather conditions can play a significant part in tactics and timing.

The following features may be on the maps:

- ◆ Maximum of 12 different types of terrain.
- ◆ Nationality flags indicating city, port, and airfield ownership.
- ◆ Victory hexes which have a brighter nationality flag and a gold border.
- ◆ Mud and snow conditions, represented by a change in the color of the map hexes.
- ◆ Neutral hexes, bordered in blue (e.g., Sweden or Switzerland). No units may enter these hexes.

### Beginning and Ending a Battle

You begin a battle by selecting a scenario of the campaign game. In the campaign game, you control a core group of units through the various battles you fight. Other auxiliary units are provided to you for that battle only. Surviving core units gain experience over time, and your unit combinations reflect your own preferences. Later campaign scenarios allow more core units.

Set-up is automatic in scenarios, while in the campaign games you deploy your core units within specified deployment areas.

## ***Air and Naval Transport Points***

At the beginning of each scenario which uses air and/or naval transport, air and naval transport points are allocated to each side. The number of points currently available to you appears when you press the Embark/Disembark button. These points are used temporarily for moving units by air and sea. A point is subtracted from the appropriate pool when a unit is embarked and added back when the unit disembarks. See the menu description of “Embark/Disembark” on page 24 for more information.

## ***Automatic Resupply***

The following automatically resupply at the end of a turn: air units on friendly carriers, or on or adjacent to friendly airfields; naval units in friendly ports; and ground units which have not acted. The resupply rate is limited by the proximity of enemy units, terrain, and bad weather. See



the menu description of “Supply Unit” on page 23 for more information.

## ***Combat***

Combat takes place when you order a unit to attack another unit. Eligible targets are indicated by the highlight becoming a set of red cross-hairs. Units with ranges of one or more hexes can make ranged attacks, i.e., shooting at the enemy without the enemy being able to shoot back (except that capital ship class units can shoot back when shot at by other capital ship units).

The order in which each unit shoots is affected by initiative and experience. Unless in a city or other terrain where the unit’s initiative is limited, or facing a rugged defense (in which case the attacker’s base initiative is set to 0 for the combat), each side’s experience level and initiative are added to a random score of 0, 1, or 2 and the unit with the higher score shoots first. If there is a tie, both shoot simultaneously.

A rugged defense can occur in two ways: (1) if a unit’s movement takes it into the hex of a hidden enemy, an ambush occurs (for air and naval units this misfortune is called “out of the sun” and “surprise contact”), which is automatically treated as a rugged defense, and (2) if an entrenched unit is attacked in a non-ranged attack by any unit other than a pioniere or engineer, there is a risk of a rugged defense based on

*Be careful to monitor your ammo and fuel levels when in desert terrain.*



the relative experience and entrenchment rates of the two units and the defender's entrenchment level. If the entrenchment level is 0, there is no risk of a rugged defense.

Each unit's non-suppressed strength points are assumed to shoot using their respective attack and defense values. Suppressed elements do not count in the firing order, but suppression other than suppression from level bombers lasts only for the duration of the current combat. The attacker's strength points are halved by mud or snow for ground units. Air units may not attack in rain or snow. Strength points are also halved if the unit has run out of fuel (if it runs out of ammo, it can't attack).

Under certain circumstances, units near the defending unit shoot at the attacker before normal combat begins. Artillery units contribute defensive fire in support of any adjacent ground units. Air defense units contribute defensive fire against air attacks against any adjacent ground units. Fighters adjacent to defending bombers or ground units may intercept attacking air units (but fighters may only make one interception per turn, and each attacking air unit may only be intercepted once). Each of the above occurs prior to normal combat and without the attacker being able to shoot back. Losses and suppression from defensive fire carry over into the remaining combat. If the attacker has no more strength points in the firing order, all of them having been destroyed or suppressed, the attack is broken off immediately.

Each time a unit shoots it uses one ammo point. Defending units can easily use up several points of ammo in a single turn when defending themselves or adjacent units.

## Continuing a Campaign Game

When you successfully complete a campaign scenario, a window appears which shows you a password. This password allows you to leave PANZER GENERAL and come back at a later time to resume the campaign. You are prompted for the password when the Restore option is selected from the Start Game menu.

## Deploying Troops After Successful Scenarios

At the beginning of a new campaign scenario, you need to deploy your core units prior to the first turn. You will see the Tactical Map for the scenario, and the first unit on your core roster will be your cursor. Your deployment area will be displayed as lighter colored hexes on the Tactical Map for the current scenario. Pressing the Next or Previous buttons will cycle through your roster; pressing the x button places the unit. **Note:** Once a unit has been placed, it cannot be moved until the game begins.



Pressing the □ button will give you the option to start the current scenario, even if you have not deployed all your units. Any units remaining on your roster can be deployed as though you had purchased them.

Pressing the ○ button opens the Upgrade Screen, where you can upgrade and/or deploy units. For more information on upgrading units see the “Upgrade” section on page 25.

## Difficulty Settings

The Set Difficulty Menu offers choices of: EASY, MEDIUM, HARD, or CUSTOM. The CUSTOM setting allows you to choose how much experience and prestige the computer is given during play, and gives you the chance to adjust the computer’s “Artificial Intelligence” (AI).

## Glossary

The Go to Unit, Purchase, and Upgrade screens all have a ? button next to the Prestige Point total display which opens a Glossary. The Glossary can also be reached using the Information button on the Start Game Menu. Glossary entries contain useful information regarding specific unit types.

## ***Go to Unit***

The Go to Unit screen, available through the Main Menu, provides an overall view of which units have moved and which have not. Green lights indicate which units have yet to move. The screen also displays: unit strength, experience, name, ammo, fuel, and statistics. To view all of your units, use the Next and Previous buttons to see your other units of that type. Highlighting a unit and pressing the Go To Unit button returns to the Tactical Map with that unit ready to be activated. Press the x button to activate that unit.

## ***Initiative***

Initiative is determined by the equipment used in battle, the terrain upon which the battle takes place, and the experience of the units. It is also adjusted by a randomly generated score of 0-2.

If an ambush or rugged defense occurs, the attacker's initiative is 0.

## ***Movement***

Each unit has a movement point allowance per turn that is spent as it moves. The movement point cost of each hex depends on the terrain in the hex, weather conditions, and the unit movement type. When you highlight a unit that has not moved, the hexes the unit can move to light up. Every movement point a unit uses costs 1 fuel, except that when the ground is covered with snow all ground units pay 2 fuel points per movement point.

Movement ends prematurely if a moving unit moves adjacent to or is ambushed by (moves into) a previously hidden unit. An ambush is treated as an attack with the defender receiving an automatic rugged defense. Entering a river hex ends a ground unit's movement, except when the river surface is frozen. The ground unit may exit river hexes normally the following turn. Entering a mountain hex ends a ground unit's movement until the next turn. Dismounted bridging engineers may serve as bridges.

## ***Order Air Units***

Air units which are low on fuel and have not been moved in your turn require orders to return to a friendly air base. You can tell when an air unit is low on fuel because a window appears to notify you that this particular unit must refuel or it will crash. If you do not move them to a friendly air base, the units may not make it back the next turn and disappear from the screen, having plummeted to their doom.

## ***Overstrength Size***

A unit with an experience level of 1 or greater, represented by at least one gold star, may be made temporarily overstrength by adding elite replacements when it is already at 10 or more strength points. You may only do this as long as the current unit strength is less than 10 plus the unit's experience level. Each time the player takes elite replacements under these conditions the strength of the unit increases by 1.

## ***Prestige Points***

Prestige points represent the influence you have earned with the high command by taking and holding cities, destroying enemy units, and winning battles as quickly and decisively as possible. In the same manner, however, losing cities and battles costs you prestige. You can exchange prestige points for new units, replacements, and new equipment for existing units. You must pay the full prestige cost of new equipment even if the cost of the new equipment for a unit is less than that of the old equipment given up. In some instances prestige may also be used to influence the course of events.

## ***Refueling Air Units***

When the fuel warning window appears, the air unit has used up half or more of its fuel and you should start checking to make sure it has sufficient fuel to return to a friendly airbase. Air units that run out of fuel, which are not on or adjacent to an airfield or on a carrier, crash and are destroyed. Air units use a minimum of half their movement allowance in fuel every turn.

## ***Scoring and Victory Conditions***

There are victory objective hexes (brighter flags in hexes with gold borders) on the map of the scenario (on the Strategic Map, Axis victory objectives are outlined in gold, Allied victory objectives are outlined in green). The score, or tally, of both Axis and Allied units destroyed in battle is displayed in the Show Score section of any Menu.

## ***Spotting***

If Hidden Units On/Off is on, all units become hidden at the beginning of each turn except those that are within 1 hex of a friendly city, port, or airfield or within the spotting range of friendly units. Air units' spotting range is halved by overcast weather and reduced to 1 hex when it is raining or snowing. Other units' spotting ranges are halved when it is raining or snowing.

Once a hex is spotted during a player's turn, it remains spotted for the entire turn. Any time a friendly unit moves and does not abort its move, it spots all hexes within its spotting range.

Enemy units within your unit's spotting range are automatically spotted except for enemy U-boats, which you have a 50% chance of spotting unless they are adjacent to one of your units.

### ***Rugged Defense***

Rugged defense can occur in two ways: if a unit's movement path takes it into the hex of a hidden enemy a rugged defense occurs automatically; or if an entrenched unit is attacked by a non-ranged, non-pioniere, or non-engineer unit. Unit entrenchment value, experience, and ambush chances are variables used in weighing the chance of rugged defense.

### ***Supply***

There are two types of supply: ammunition and fuel. Each time a unit shoots, it uses one point of ammo. Every movement point a unit uses costs it one point of fuel. Exceptions: when the ground is covered with snow all non-air units use 2 fuel points for each movement point.

At the end of each turn the following automatically resupply: air units which are on or adjacent to airfields, naval units which are in port, and ground units which have not acted. Ground units may not resupply, however, if there are enemy units adjacent to them and if they are not in a town. Rain, snow, and desert conditions also limit resupply.

Air units which are out of fuel and not adjacent to an airfield are eliminated.

Units normally receive 1/2 their ammo and fuel maximums during resupply. Units receiving Replacements or Elite Replacements automatically receive resupply.

### ***Transports***

All cities adjacent to an ocean hex act as ports for the purpose of embarking on troop transports. At the beginning of each scenario that uses air and naval transport, points are given to each side. These points represent the allocation of air transports and naval transports to your army. These points are used to move units around the map and over the sea. When you move the highlight over a friendly port, coastal port, or airfield, the current points appear at the top of the screen. When you embark a unit, one point is deducted from available transport. When you disembark a unit, one point is added to available transport.



Organic transport is transport which is permanently assigned to a unit and cannot be shared (i.e., trucks or half-tracks).

### ***True Neutrals***

True neutrals are countries like Sweden or Switzerland which no one is allowed in or over. These hexes are indicated on the Tactical Map with blue hexes.

### ***Turn Sequence***

In a given turn a unit can move once and attack once, in either order, except for artillery and air defense units which may only shoot before moving. After you have selected a hex to move to, but before attacking from that hex or selecting another unit, you may elect to Abort Move unless you contacted or moved adjacent to a previously hidden unit in the course of your move. Units may also take a variety of other actions, some of which are limited to the beginning or end of the unit's turn and some of which take the entire turn. See the "Unit Menu" section on page 23 for more information.

### ***Unit Experience***

Each time a unit takes part in a combat it gains experience. Every 100 points equals an experience level. The maximum experience level a unit can achieve is 5. When two units are in combat, their experience levels are compared and the difference modifies the outcome. Experience also determines overstrength size, influences ambush chance, and modifies initiative. For more information on experience, refer to the "Experience/Battle Honors" section on page 27.

### ***Victory Conditions***

Battles are won by taking or holding some or all of the victory objective hexes (depending on the scenario), which are represented by gold-bordered hexes with brighter national flags on the Tactical Map and by green or white hexes on the Strategic Map. Capturing towns that are not victory objectives gains you prestige points, but does not affect the victory conditions, so you should always focus on capturing the objectives you have been ordered to take. Only units of the tank, antitank, recon, and infantry classes can capture cities, ports, and airfields, although other troop types can occupy them and prevent their use by the enemy.

*Proper use of self-propelled artillery enhances the defense of adjacent units.*



## ***Weather***

Weather is randomly determined based on actual weather conditions for the month of the year and weather zone in which a battle occurs. Weather may change between fair weather and storm fronts. Storm fronts can last for a number of days and have the possibility of generating only overcast weather or becoming rainstorms or snowstorms. It never rains or snows in North Africa. **Note:** Aircraft units may not attack during rainy weather.

## ***Zone of Control***

A unit exerts a zone of control into the six hexes around it. Surface units' zones of control affect only surface units and air units' zones of control affect only air units. When you move a unit into the zone of control of an enemy unit, your unit's movement is stopped and it must either attack or end its turn. If your unit was ordered to move to a point which takes it through a hex occupied by a previously hidden enemy unit, your unit is ambushed by the enemy unit and your unit's turn ends after combat is resolved.

## UNIT CLASS DESCRIPTIONS

All pieces of equipment, referred to as units, are grouped into one of 18 different classes of equipment in PANZER GENERAL. Below is a list describing the 18 classes, types available within each class, and their tactical role.

### Ground Classes

#### *Anti-Aircraft*

The primary use of the anti-aircraft (AA) class is to respond quickly to enemy air units. Unlike the air defense class, AA units may fire and move or vice versa and can attack ground units. AA units can keep up with a quick moving attack force, and if properly used, assist in mopping up enemy infantry. Protect AA units from enemy tank, anti-tank, and artillery units and you may find them very useful. Unlike air defense units, AA units must be in the same hex as enemy air units to attack them.

#### *Air Defense*

Like artillery, air defense units cannot attack after they have moved; unlike artillery, however, they cannot attack ground units. They are ideally suited for defending relatively stationary ground units against enemy airpower in defensive battles, but given time and proper protection, they can also be useful when brought up to support your offensives by fending off enemy aerial counterattacks. Because of their ranged attack and protective fire capability, well placed air defense units can keep enemy aircraft at bay around a vital city, or protect a difficult ground assault from disruption.

#### *Anti-Tank*

The anti-tank (AT) class is divided into two unit types: towed anti-tank weapons and self-propelled anti-tank weapons — the latter often referred to as “Tank Destroyers” (TDs). The towed type are excellent on defense, especially if heavily entrenched, but their vulnerability while being towed by trucks or half-tracks makes them difficult to use effectively on the attack. When attacking, use tank destroyers instead. TDs are much cheaper than tanks for the equivalent gun size, but less well-armored and usually lack a turret. This means that they can use their initiative to get in the first shot when defending against tank attacks, but always fire second when attacking tanks themselves. This makes attacks on tanks risky unless they are already seriously weakened. The key to TD tactics against tanks is moving offensively but fighting defensively — rather than attacking enemy armor,

move TDs into positions where the enemy armor is forced to attack you. For example, while your tanks strike deep through enemy lines, TDs can be used to block enemy armored counterattacks on the flanks of the advance. Although their intended purpose is to fight tanks, TDs make excellent tank-substitutes for overrunning other troops.

## ***Artillery***

Artillery cannot attack after moving. Artillery units, like anti-tank units, are divided into towed and self-propelled categories. The difference is less significant because they are too vulnerable, even when armored, to confront the enemy directly — their role is instead to bombard the enemy from a distance in support of other friendly troops. The main advantage of self-propelled artillery is that it can keep moving without having to mount and dismount. Towed artillery, in comparison, is very vulnerable and unable to fire in defense of itself on adjacent enemy units. Artillery is suitable for softening up enemy soft targets prior to an offensive attack (even if they inflict no losses, each bombardment attack reduces the enemy's entrenchment level), and equally valuable because of its ability to provide defensive fire when adjacent ground units are attacked by enemy ground units. Artillery is best deployed immediately behind friendly units where it can support them on both offense and defense. Artillery support is especially critical if you want your infantry to have a chance of stopping armored attacks in the open.

## ***Fort***

The fort class is divided into two types: "forts," which are networks of immovable, strongly-built heavy artillery and infantry positions; and "strongpoints," which are lighter networks of pillboxes and light field fortifications. Since forts have ample reserves of ammo and strong attack values, they should shoot aggressively at any enemy that approaches. A combination of artillery and aerial bombardment followed by an assault by engineer or pioniere units is the proven method of capturing enemy forts and strongpoints that cannot be bypassed.



*Infantry units are the best assault forces in rough terrain.*

## ***Infantry***

The infantry class consists of several different types of units. Infantry are the most common troop type in any army and are the most versatile. Their advantage lies not in their speed but in their ability to fight in cities, forests, and other difficult terrain without the penalties suffered by most other classes. Although vulnerable to artillery fire and armored vehicles when in open terrain, they are almost impossible to dig out of well-entrenched defensive positions unless attacked by other infantry and artillery in coordination. Even the most powerful armored offensive can be halted or seriously delayed by a single well-positioned and well-entrenched infantry unit if the armored units lack proper support.

Engineer and pioniere units are excellent at assaulting heavily entrenched positions because their special training and equipment enables them to avoid the risk of a rugged defense. Bridging engineers, indicated by a bridging icon, carry bridging equipment that allows them to serve as a bridge for other friendly units while dismounted in a river hex. Paratroops and rangers are lightly-armed but highly-trained infantry able to paradrop from air transports. Heavy weapons infantry have higher attack values than ordinary infantry and so are more suitable for assault roles, but move more slowly, making them prime candidates for transporting. Cavalry in this period are actually mounted infantry, with relatively low combat values but high mobility without the expense and vulnerability of organic transport.

*Tanks are most effective in open terrain.*



## ***Recon***

The recon class consists of highly mobile but lightly armored units with superior spotting ranges (which is very important if using realistic spotting rules). They can pinpoint the location of enemy units, seize and hold cities and other objectives temporarily, and successfully attack weakened enemy units and vulnerable units such as units mounted on organic transport. Recon units are most useful in offensive battles, and having one as a pathfinder for each major advance saves you time and helps you avoid ambushes.

## ***Tank***

The tank class is at the heart of PANZER GENERAL. This is not because they were all-powerful, but because they were the key ingredient in the combined arms blitzkriegs that stunned the world in the early campaigns of the war. The tank class is most able to take aggressive risks and survive because of its speed, armor, and heavy weaponry. But beware of overconfidence — although tanks dominate open country, they are vulnerable to infantry in cities, forests, and rough terrain; they can be stopped by antitank guns and tank destroyers; and they require air support when the enemy is able to use tactical bombers against them. A successful general does not win with tanks alone.

## ***Truck***

The truck class includes trucks, half-tracks, and a few fully-tracked vehicles used as organic transport (i.e., it is specifically assigned to a unit and cannot be shared). Organic transport is useful for giving otherwise slow units greater mobility but, while mounted, units use the weak combat values of the transport and are easily destroyed. Troops moving by truck should therefore be protected from enemy ground and air attack at all times. Trucks are cheaper and faster on roads, but half-tracks are more sturdy (a good value for expensive units) and move more quickly in difficult terrain.

## **Air Classes**

### ***Air Transport***

Most scenarios include a pool of air transport points. Air transport is non-organic transport which allows infantry, light artillery, and light anti-tank units to embark at friendly airfields and disembark at any unoccupied airfield (enemy airfields may be seized in this way). Paratroops and rangers can attempt to “jump” into any non-sea hex. See the “Embark/Disembark” description in the Unit Menu section on page 24 for information about transporting infantry by air. Note that air transports are highly vulnerable to both enemy fighters and air defense units and require fighter escorts, particularly for paradrops behind enemy lines.

### ***Fighter***

The fighter class is your key to obtaining air superiority. The fighter class is highly effective when attacking enemy air units, and is able to protect adjacent friendly bomber and ground units through its ability to intercept air missions against them. Fighters can strafe infantry, artillery, and transport units with some effect and help soften up entrenchments, but their primary mission is to clear the skies of enemy fighters and enemy bombers. Losses in fighter combats are typically heavy, so getting the first shot through superior initiative and experience is critical.

### ***Level Bomber***

The level bomber class consists of high-altitude, long-range bombers with large bomb loads but limited accuracy. They attack by “carpet bombing” ground targets including cities, ports, and airfields. They tend to suppress rather than destroy targets, but this is advantageous because enemy units

suppressed by your level bombers remain suppressed until the end of your turn. Successful attacks by level bombers reduce fuel and ammo points of enemy units. Level bombers are the only class that can assist other units' attacks by inflicting prolonged suppression.

Level bombers only attack the hex they are in, and are immune to all ground units except for AA units and air defense units. When they bomb a victory hex, located in a city, port, or airfield, they inflict prestige damage on the enemy and have a significant chance of neutralizing the target (neutralized targets have no nationality flags). Only dismounted infantry can recapture/repair a neutralized city, port, or airfield.

### ***Tactical Bomber***

The tactical bomber class includes aircraft designed for ground attack, which can only attack ground targets; and fighter-bombers, which can also attack enemy air units (though they are generally less effective than fighters). Tactical bombers are useful against a variety of targets, including typically vulnerable targets such as transport and artillery, but also against more difficult targets such as the submarine, tank, and antitank classes. Tactical bombers can also be used to soften up entrenched positions. Note that fighter escorts are essential to the survival of tactical bombers if the enemy possesses fighters.

## **Sea Classes**

### ***Capital Ship***

The capital ship class includes battle ships, battlecruisers, heavy cruisers, and light cruisers. Capital ships have the ability to make ranged attacks and may move and shoot in either order. They are best used to defeat the enemy fleet, but after a naval victory can support the ground forces with shore bombardment, especially against soft targets. Capital ships shot at by other capital ships are entitled to shoot back with a ranged attack with any surviving unsuppressed strength points. All capital ships repair extremely slowly, making it rarely worthwhile to obtain replacements for them.

### ***Carrier***

The carrier class acts as a mobile airfield for fighters and tactical bombers, but, unlike airfields, carriers can resupply only air units in the same hex. Carriers have excellent spotting ranges but are vulnerable to naval attacks, and their high cost makes them very lucrative targets in terms of prestige. Carrier class ships also repair slowly.



## ***Destroyer***

The destroyer class consists of destroyers, destroyer escorts, patrol craft, and torpedo boats. Destroyer class units are the only naval units able to attack submarines (and attack first during their turn) but are easily destroyed by capital ships. Use screens of destroyer class vessels to protect heavier ships from submarines. Together with tactical bombers, they can form effective sub-killer task groups.

## ***Sea Transport***

Sea transport is extremely important in amphibious invasion scenarios such as Norway or Crete. Sea transport is non-organic transport which allows ground units to embark at friendly port facilities or coastal cities and disembark in any unoccupied coastal hex. See the "Embark/Disembark" description in the Unit Menu section on page 24 for information about transporting units by sea. Note that sea transports should be protected by naval and air covering forces because they are highly vulnerable to enemy naval units and, to a lesser extent, to enemy tactical bombers.

## ***Submarine***

The submarine class can be deadly against enemy heavy naval units because destroyer class naval units and tactical bombers are the only units that can attack them. Submarines always shoot first when they attack during their turn. When submarines are attacked, they are often able to evade the attack by maneuvering or submerging.

## CREDITS

Producers	<b>John Eberhardt, Tom Wahl</b>
Associate Producers	<b>Rick Martinez, Jason Ray</b>
Game Design	<b>SSI Special Projects Group</b>
Campaign Game Design	<b>Joel Billings</b>
Scenario Design	<b>Chuck Kroegel</b>
PlayStation Manual	<b>Mark Whisler, Jonathan Kromrey</b>
Original Programming	<b>Paul Murray</b>
Programming for PlayStation	<b>Robert Calfee</b>
Additional Programming	<b>Keith Brors</b>
Art	<b>Dave Jensen</b>
Audio Programmer	<b>Ralph Thomas</b>
Voice Director	<b>Tim August</b>
Voice	<b>Barry Lank</b>
Map Design	<b>Michael Kroon, Shane Hensley</b>
Data Manager	<b>Caron White</b>
Test Supervisor	<b>Glen Cureton</b>
Lead Product Tester	<b>John Cloud, John Peña</b>
Other Product Testers	<b>Kelly Calabro, Brian Harp, Aaron Malchow</b>
<b>Executive Producer</b>	<b>Brett Berry</b>
Graphic Design and DTP	<b>LOUIS SAEKOW DESIGN: David Boudreau, Leedara Zola</b>

### *Special Thanks (Alphabetically) To*

Joe Almanza, Mike Bench, Doug Brandon, Ron Calonje, Chris Clifford, Josh Cloud, Ben Cooley, Lee Crawford, Jason Dawdy, Diane Duffey, William Dunn, Forrest Elam, Jeff Groteboer, Annette Grove, Eileen Matsumi, Don McClure, Bruce Mickelson, Jeff Peña, Rick White, James Young

## STRATEGIC SIMULATIONS, INC. LIMITED WARRANTY

Strategic Simulations, Inc. ("SSI") warrants that the media on which the enclosed program is recorded will be free from defects in materials and workmanship for a period of 30 days from the date of purchase. If within 30 days of purchase the media prove defective in any way, you may return the media to **Strategic Simulations, Inc., 675 Almanor Avenue, Suite 201, Sunnyvale, CA 94086-2901** and SSI will replace the media free of charge. In addition, if the media prove defective at any time after the first 30 days, return the media to SSI and SSI will replace the media for a minimum charge of \$10.00 plus \$4.00 for shipping and handling. California residents, add applicable sales tax.

SSI MAKES NO WARRANTIES, EITHER EXPRESS OR IMPLIED, WITH RESPECT TO THE SOFTWARE PROGRAM RECORDED ON THE CD OR DISKETTE OR THE GAME DESCRIBED IN THIS RULE BOOK, THEIR QUALITY, PERFORMANCE, MERCHANTABILITY OR FITNESS FOR ANY PARTICULAR PURPOSE. THE PROGRAM AND GAME ARE SOLD "AS IS." THE ENTIRE RISK AS TO THEIR QUALITY AND PERFORMANCE IS WITH THE BUYER. IN NO EVENT WILL SSI BE LIABLE FOR DIRECT, INDIRECT, INCIDENTAL, OR CONSEQUENTIAL DAMAGES RESULTING FROM ANY DEFECT IN THE PROGRAM OR GAME EVEN IF SSI HAS BEEN ADVISED OF THE POSSIBILITY OF SUCH DAMAGES. (SOME STATES DO NOT ALLOW THE EXCLUSION OR LIMITATION OF IMPLIED WARRANTIES OR LIABILITY FOR INCIDENTAL OR CONSEQUENTIAL DAMAGES, SO THE ABOVE LIMITATION OR EXCLUSION MAY NOT APPLY TO YOU.)

The enclosed software program and this rule book are copyrighted. All rights are reserved. This rule book may not be copied, photographed, reproduced, or translated or reduced to any electrical medium or machine-readable form, in whole or in part, without prior written consent from SSI. The program accompanying this rule book may be copied, by the original purchaser only, as necessary for use on the computer for which it was purchased.

Any persons reproducing any portion of this book for any reason, in any media, shall be guilty of copyright violation and subject to the appropriate civil or criminal action at the discretion of the copyright holder(s).

©1995 Strategic Simulations, Inc. All Rights Reserved.

### WHAT TO DO IF YOU HAVE A DEFECTIVE CD OR DISK

Each of our games undergoes extensive playtesting prior to its release. Through this process we hope to uncover and correct any errors in programming. However, due to the complex nature of our simulations, some program errors may go undetected until after publication. In addition to errors in the program, there are occasionally problems with the media itself. We experience the industry standard of approximately a 3 to 5% failure rate of duplicated disks. Before assuming that the media is defective, make sure to check your disk drive. Up to 95% of the media returned to us as defective will run fine on our computer systems. Often the problem is with a disk drive that needs servicing for alignment, speed, or cleaning.

Should you have defective media, please return the disk or CD only (keep all other parts of the game) to our Customer Support Department, along with a note describing the problem you have encountered. Replacement media will be provided upon our receipt of the defective media.

Should you uncover an error in the program, return both your game disk and any "save game" disks to our Customer Support Department. Please enclose a description of what was taking place in the game when the error occurred. Upon correction of the program error, we will return an updated disk to you.

---

**Always include your name, address, and daytime telephone number with any correspondence. We will do our best to see that any problems are corrected as soon as possible.**

---

### QUESTIONS OR PROBLEMS?

Our main business number is (408) 737-6800. **If you encounter disk or system related problems you can call our Technical Support Staff at (408) 737-6850 between 11 a.m. and 5 p.m., Pacific Time, Monday through Friday, holidays excluded.** NO GAME PLAYING HINTS WILL BE GIVEN THROUGH THIS NUMBER. You can write to us for hints at: Hints, Strategic Simulations, Inc., 675 Almanor Avenue, Suite 201, Sunnyvale, CA 94086 (include a self-addressed, stamped envelope for reply).

---

# PANZER GENERAL™



A MINDSCAPE® COMPANY

Strategic Simulations, Inc.  
675 Almanor Avenue, Suite 201  
Sunnyvale, CA 94086

PANZER GENERAL is a trademark of Strategic Simulations, Inc., a Mindscape Company. ©1995 Strategic Simulations, Inc. All rights reserved.

PlayStation and the PlayStation Logos are trademarks of Sony Computer Entertainment Inc. The rating icon is a registered trademark of the Interactive Digital Software Association. Manufactured and printed in the U.S.A.

U.S. AND FORIEGN PATENTS PENDING.